



# COMPLEMENTARY

PROCESSING  
SOLUTIONS

■  
CORNERS GRINDING MACHINES  
HORIZONTAL DRILLING MACHINES



**LATTUADA**  
+ ADDING VALUE



## COMPLEMENTARY PROCESSING MACHINES



### **DELTA SERIES**

Corners grinding machines

14

---



### **TP SERIES**

Horizontal drilling machines

18

---

# ADDING VALUE

## THE INESTIMABLE VALUE OF GIVING AND RECEIVING

### THE VALUE RECEIVED

Every person who has trusted Lattuada has enriched its story. Each glass (or stone) processing solution completed and put into production has added even more experience and drive.

### THE VALUE OFFERED

Building on many years of market knowledge and a vast portfolio of successful projects, Lattuada continues to invest in development, research and training. With continually updated internal and external feedback, it strives to offer more quality, more solutions, more technology.

# ADDING + VALUE

## A SYNERGY OF VALUES CALLED A COMPANY

### Quality and personalisation

---

Are the hallmark of Lattuada's design. Attention to every detail is pursued within a customised production process, with care and attention.

### Flexibility and assistance

---

Maximum willingness to listen and develop the client's requests. Guarantee of follow-up and further customisation throughout the machine life cycle.

### History and experience

---

Since 1978, day after day, milestone after milestone, Lattuada has continued to grow in its problem-solving capacity and in guaranteeing progressive know-how to all its customers.

### Internationality and italianity

---

Made in Italy represents worldwide excellence in the glass sector. The sense of belonging coexists with the pride of constantly interacting with an international audience.

### Innovation and substance

---

Proposing new solutions is part of Lattuada's DNA. Simplification, training and constant support are the pluses offered to combine technology and user-friendliness.

### Eco-Sustainability and territory

---

Starting from the Italian headquarters, concrete actions for the environment have been undertaken for years. Likewise, Lattuada's solutions will be increasingly 'green'.

# integrAL

## ADDING VALUES FOR INTEGRAL SOLUTIONS

INTEGRAL IS LATTUADA'S COMBINATION OF PRODUCTS, SERVICES AND TECHNOLOGY TO OFFER A SINGLE, CENTRALISED MANAGEMENT IN GLASS AND STONE PROCESSING.



### SPECIAL MACHINES SOLUTIONS

Do you have any special needs?  
Out-of-standard processes?  
Do you treat composite materials?  
That's not a problem.  
We can find the most suitable solution for you and customise our machines to ensure you get the flexibility you need.



### STONE SOLUTIONS

Lattuada's many years of know-how transferred to natural stone, ceramic and composite material processing: PetrA, vertical edge polisher - Works with precision and quality on all types of edges, and, thanks to its natural versatility, is perfect for Stone Professionals production facilities.

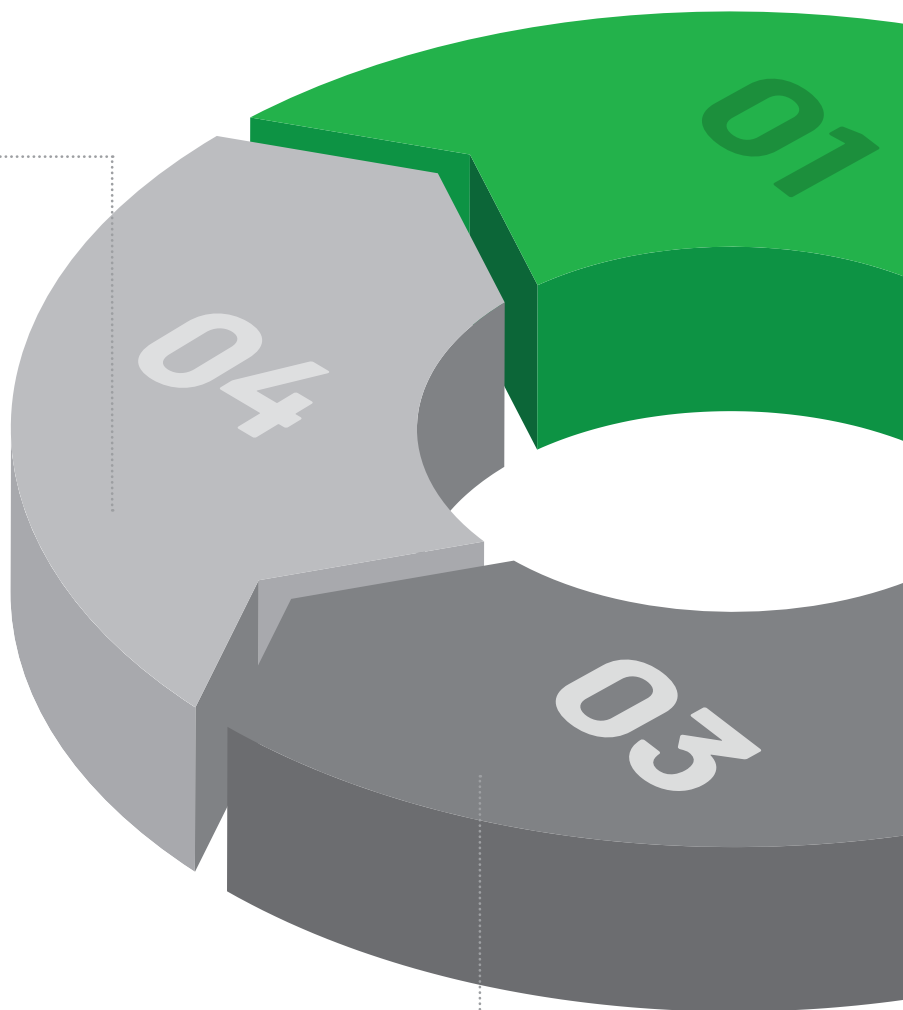



## GLASS SOLUTIONS

Customisation, precision, versatility: all of Lattuada glass processing lines ensure excellent performance and high productivity, integrating perfectly into company realities. A combination of experience and innovation to meet any kind of challenge.



### > Grinding

Our strength, always. A variety of solutions taking the shape of a wide range of machines: more than 40 models that can be specifically configured to ensure maximum productivity.



### > Washing

For more than 15 years we have been studying and providing solutions for glass washing. We offer a full range of high-tech, vertical washing machines that are easy to use and maintain.



### > Complementary processing

Do you need to drill or process corners? We can provide a complete range of horizontal drilling machines and automatic radius and straight corners grinding machines.



## AUTOMATION SOLUTIONS

Robotics, A-WR & i-AL Systems, Augmented Reality and IoT: a beating heart of innovation and technology revolutionising glass and stone processing. Lattuada Automation Solutions bring companies into the world of Industry 4.0, by making every machine a concentrate of precision, productivity and automation.

“ Made in Lattuada integrated solutions, to meet all your needs ”

AUTOMATIC MACHINES  
 A-WR & i-AL Systems  
 ROBOTIC SOLUTIONS  
 AR ASSISTANCE  
 IOT

# AUTOMATION SOLUTIONS

## AUTOMATIC MACHINES

Solutions for automating activities and increasing production flexibility

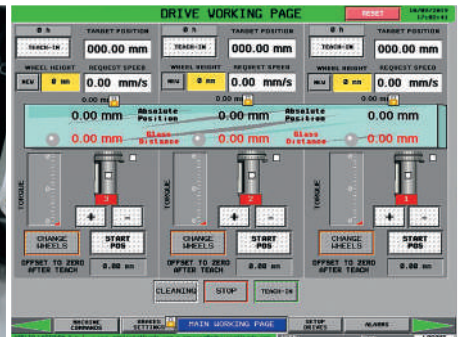

### A-WR SYSTEM

Introduces a completely automatic wheels setting management.



### i-AL

A comprehensive pack of mechanical, electronic and software systems especially designed to deliver the maximum possible automation in glass processing and a full integration with your entire production system.



Lattuada brings companies into the world of Industry 4.0, by making every machine a concentrate of precision, productivity and automation.

**EVERY CUSTOMER IS UNIQUE TO US...**  
AS UNIQUE AS OUR SOLUTIONS

# ROBOTS

New **integrated, flexible** and **customised** solutions

\* 2 edgers and 2/3 robots

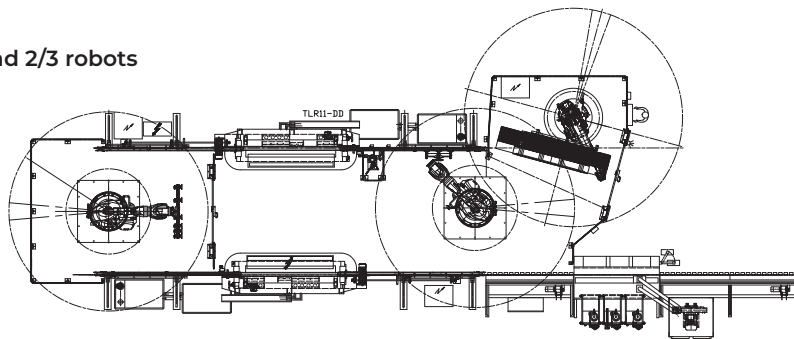

**A PERFECT SYNERGY WITH TECHNOLOGY**

In partnership with:



**Different configurations available for the implementation in several applications:**

**2 EDGERS AND 1 ROBOT**

The most sold

\* **2 EDGERS AND 2/3 ROBOTS**

For fully automated cells

**1 EDGER AND 1 ROBOT**

Fully automated cell in a reduced space

**4 EDGERS AND 3 ROBOTS**

Special solutions

**INTEGRATION**

With washers, CNCs, double-edgers, cutting, tempering or IG lines, etc.

# INDUSTRY 4.0

Industry 4.0 has already become an active part of many companies, becoming a strong competitive factor. An approach that deeply changes the production process by implementing enabling technologies: a leap you can already take into the future through **Adelio Lattuada** products.

**SOLUTIONS FOR TRANSFORMING PRODUCTION AND BECOMING A SMART FACTORY**

As a matter of fact, thanks to the **PLM IOT i-Like Machines software**, besides connecting machines to each other so as to monitor them constantly, we also provide clear data through an interface that is intuitive and easy to use.

CORNERS GRINDING MACHINES  
AND DRILLING MACHINES

# SOLUTIONS FOR COMPLEMENTARY PROCESSING



**performing**  
high speed

**Corners grinding machines:**  
cycle time less than 30"  
for thicknesses up to 20 mm.



**productive**  
smart technology

**Drilling machines:** laser centring  
system and supports for drilling  
in series.



**reliable**  
little maintenance required

Machines with extremely long  
useful life and extremely  
easy to maintain.



**Specific machines for automatically processing radius and straight corners**, thus recommended for example for glassmakers who manufacture large volumes of furnishing shelves or doors.

**Complete line of automatic, semi-automatic and manual horizontal drilling machines** with one or two opposing heads.



## **flexible** customised configurations

**Corners grinding machines:** you can work on different types of corners and profiles depending on the assembled type of tools.



## **smart** simplicity of use

**Drilling machines:** automatic adjustment of the diamond tool speed by setting the drilling diameter.



## **excellent** top performance

Thanks to optionals such as the use of liquid cerium oxide, our corners grinding machines can offer high final processing quality.



# CORNERS GRINDING MACHINES

## TECHNICAL DETAILS

- 1 Movement of the **pneumatic wheel-holder units**.
- 2 Spindle **adjustment handwheels**.
- 3 Option to work in **automatic cycle**.
- 4 **Manual lubrication** of all rotary parts.
- 5 Integrated support for processing **medium size sheets**.
- 6 Simple and quick **positioning of the templates**.



# HORIZONTAL DRILLING MACHINES

## TECHNICAL DETAILS

- 1 **Automatic ejection** of the glass cores (not available for the TP 1000 version).
- 2 Laser **centring system**.
- 3 Pneumatic glass **support table**.
- 4 **Automatic adjustment of the diamond tool speed** by setting the drilling diameter (not available for the TP 1000 version).

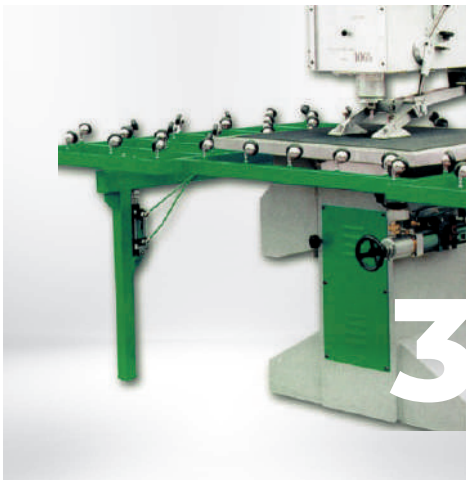
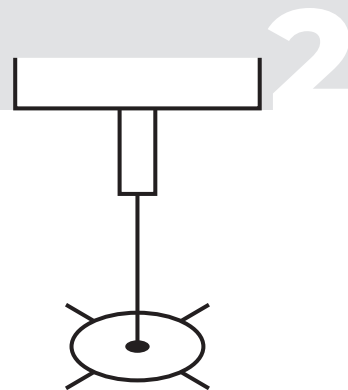

# DELTA SERIES

## SPECIFIC MACHINES FOR AUTOMATIC PROCESSING OF CORNERS

The DELTA series comprises specific machines for automatically processing corners, thus recommended for example for glassmakers who manufacture large volumes of furnishing shelves or doors. They can process radius or straight corners on thicknesses up to 20 mm in less than 30 seconds, even with liquid cerium oxide polishing.



4 - 20 mm  
5/32 - 3/4 "



10 - 150 mm  
25/64 - 6 "



10 - 200 mm  
25/64 - 7.9 "



pneumatic

## CORNERS GRINDING MACHINES DELTA SERIES

# ALL YOU NEED TO KNOW

### How flexible and modular are they?

- Simple and quick positioning of the templates
- Independent adjustment of top and bottom arris
- Integrated support for processing medium size sheets
- Table with wheels for processing large glass sheets

### Which are the production control tools?

- Spindle adjustment handwheels
- Processing speed oleodynamic adjuster

### Which components of the machine allow achieving high performance?

- Option to work in automatic cycle: cycle time less than 30" for thicknesses up to 20 mm
- Movement of the pneumatic wheel-holder units
- Device for processing small pieces

### How can I achieve higher quality?

- Liquid cerium oxide for greater processing quality

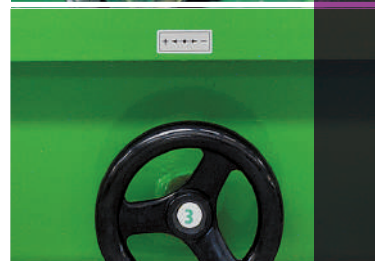
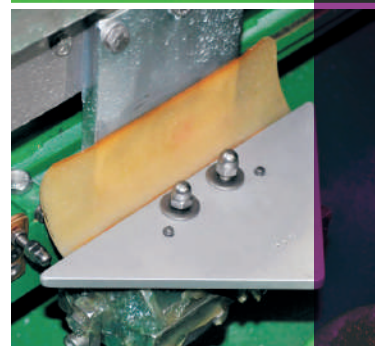
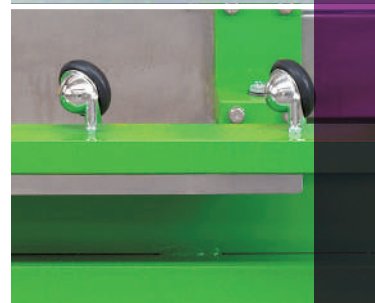
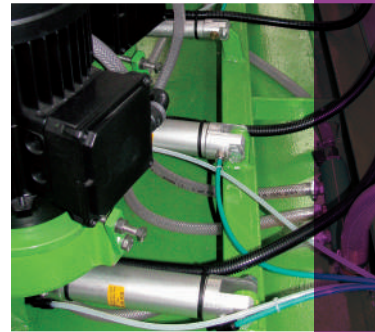

# DELTA SERIES

THE FLEET



**Corners** grinding machines



# DELTA SERIES

## Automatic machines for **processing radius and straight corners**

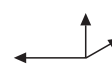

<b>DELTA M3</b>	<b>eu</b>	200x300 mm opt. 100x200 mm	1.000x1.000 mm (square glasses) 1.300x700 mm (rectangular glasses)	10 - 150 mm	10 - 200 mm	4 - 20 mm	8,5	2.200x1.150 xH1.750 mm	900 Kg
	<b>us</b>	7.9x11.8 " opt. 3.9x7.9 "	39.4x39.4 " (square glasses) 51.2x27.5 " (rectangular glasses)	25/64 - 6 "	25/64 - 7.9 "	25/64 - 7.9 "		86.6x45.3 xH68.9 "	1,984 lbs

<b>DELTA M4</b>	<b>eu</b>	200x300 mm opt. 100x200 mm	1.000x1.000 mm (square glasses) 1.300x700 mm (rectangular glasses)	10 - 150 mm	10 - 200 mm	4 - 20 mm	11	2.680x1.300 xH1.750 mm	1000 Kg
	<b>us</b>	7.9x11.8 " opt. 3.9x7.9 "	39.4x39.4 " (square glasses) 51.2x27.5 " (rectangular glasses)	25/64 - 6 "	25/64 - 7.9 "	25/64 - 7.9 "		105.5x51.2 xH68.9 "	2,205 lbs

<b>DELTA M4 C</b>	<b>eu</b>	200x300 mm opt. 100x200 mm	1.000x1.000 mm (square glasses) 1.300x700 mm (vetri rettangolari)	10 - 150 mm	10 - 200 mm	4 - 20 mm	11	2.680x1.300 xH1.750 mm	1000 Kg
	<b>us</b>	7.9x11.8 " opt. 3.9x7.9 "	39.4x39.4 " (square glasses) 51.2x27.5 " (rectangular glasses)	25/64 - 6 "	25/64 - 7.9 "	25/64 - 7.9 "		105.5x51.2 xH68.9 "	2,205 lbs

<b>DELTA M5</b>	<b>eu</b>	200x300 mm opt. 100x200 mm	1.000x1.000 mm (square glasses) 1.300x700 mm (rectangular glasses)	10 - 150 mm	10 - 200 mm	4 - 20 mm	13	3.000x1.300 xH1.750 mm	1200 Kg
	<b>us</b>	7.9x11.8 " opt. 3.9x7.9 "	39.4x39.4 " (square glasses) 51.2x27.5 " (rectangular glasses)	25/64 - 6 "	25/64 - 7.9 "	25/64 - 7.9 "		118.1x51.2 xH68.9 "	2,640 lbs

### LEGEND

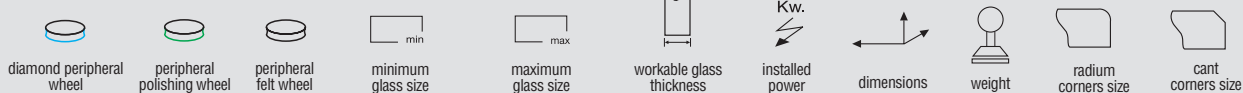

# TTP SERIES

## SEMI-AUTOMATIC AND AUTOMATIC MANUAL HORIZONTAL DRILLING MACHINES

Complete line of automatic, semi-automatic and manual horizontal drilling machines with one or two opposing heads (bottom automatic and top manual). Common features are the automatic locking of the glass during the drilling cycle and the option to adjust the drilling depth on the bottom head. Just like for all of our models, they come in various options, thus allowing utmost customisation and adaptation of the product to the various needs.



Ø 4 - 200 / 250 mm  
Ø 5/32 - 7.9 / 9.8 "

Ø 4 - 130 mm  
Ø 5/32 - 5.1 "

50 mm  
2 "

1,000 / 1,065 / 1,200 / 1,665 mm  
39.3 / 41.9 / 47.2 / 65.5 "

## HORIZONTAL DRILLING MACHINES TP SERIES

# ALL YOU NEED TO KNOW

How flexible and modular are they?

- Pneumatic glass support table
- Option to adjust the drilling depth on the bottom head

Which are the production control tools?

- Automatic locking of the glass during the drilling cycle

Which components of the machine allow achieving high performance?

- Automatic ejection of the glass cores
- Laser centring system
- Supports for drilling in series

How can I achieve higher quality?

- Automatic adjustment of the diamond tool speed by setting the drilling diameter (not available for the TP 1000 version)

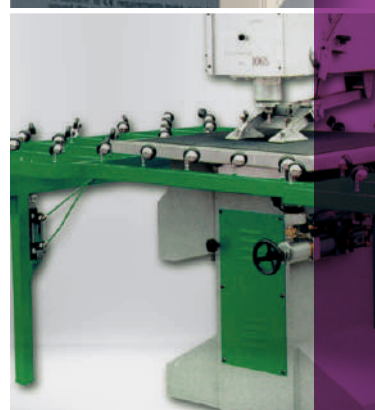

# TP SE RIES

THE FLEET

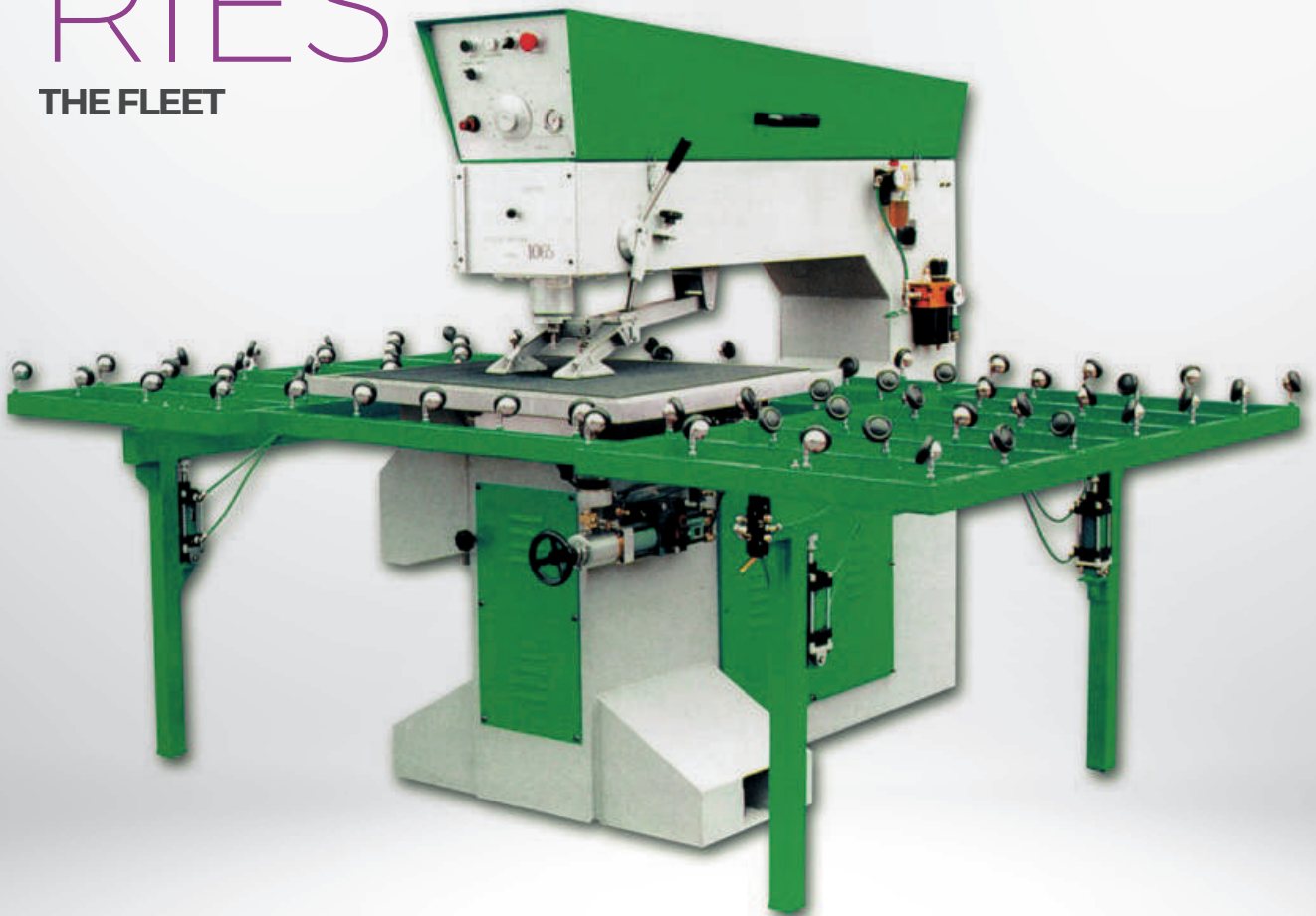

Manual and semi-automatic  
horizontal drilling machines

## SERIE TP

### Manual horizontal drilling machines

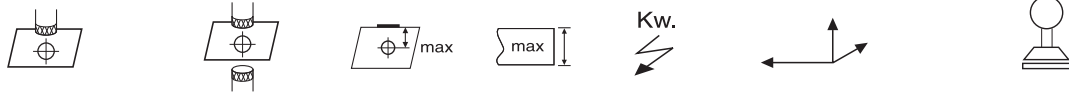

TP 1000.1H	eu	Ø 4 - 200 mm	-	1000 mm	50 mm	1,5	1.700x1.300 xH1.800 mm	270 Kg
	us	Ø 5/32 - 7.9 "	-	39.4 "	2 "		66.9x51.1 xH70.8 "	595 lbs

TP 1000.2H	eu	Ø 4 - 200 mm	Ø 4 - 130 mm	1000 mm	50 mm	2,5	1.700x1.300 xH1.800 mm	320 Kg
	us	Ø 5/32 - 7.9 "	Ø 5/32 - 5.1 "	39.4 "	2 "		66.9x51.1 xH70.8 "	705 lbs

Available also the automatic version

## SERIE TP

### Semi-automatic horizontal drilling machines

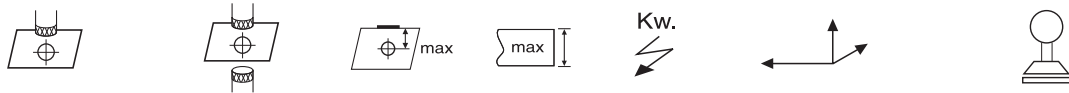

TP 1065	eu	Ø 4 - 250 mm	Ø 4 - 130 mm	1.065 mm	50 mm	3	1.700x900 xH1.760 mm	550 Kg
	us	Ø 5/32 - 9.8 "	Ø 5/32 - 5.1 "	41.9 "	2 "		66.9x35.4 xH69.2 "	1,212 lbs

Available also the automatic version

TP 1200	eu	Ø 4 - 250 mm	Ø 4 - 130 mm	1.200 mm	50 mm	3	1.900x900 xH1.760 mm	650 Kg
	us	Ø 5/32 - 9.8 "	Ø 5/32 - 5.1 "	47.2 "	2 "		74.8x35.4 xH69.2 "	1,433 lbs

Available also the automatic version

TP 1665	eu	Ø 4 - 250 mm	Ø 4 - 130 mm	1.665 mm	50 mm	3	2.700x900 xH1.760 mm	750 Kg
	us	Ø 5/32 - 9.8 "	Ø 5/32 - 5.1 "	65.5 "	2 "		106.2x35.4 xH69.2 "	1,653 lbs

Available also the automatic version

#### LEGEND



# AS BIG AS THE WORLD.

OUR SOLUTIONS ARE WORKING ALL OVER THE WORLD. SINCE 2017 WE OPERATE IN THE USA THROUGH LATTUADA NORTH AMERICA BASED IN NORTHWOOD (OHIO). A PRECISE CORPORATE CHOICE TO STAY CLOSE TO OUR CUSTOMERS BY OFFERING TOP QUALITY SERVICES AND PRODUCTS SPECIFICALLY DESIGNED FOR A DEMANDING AND COMPETITIVE MARKET THAT REQUIRES COMPLIANCE TO SPECIFIC STANDARDS.



HEADQUARTER



NORTHWOOD (OH)  
A PRECISE CORPORATE  
CHOICE TO STAY CLOSE  
TO OUR CUSTOMERS

LNA provides all pre- and after-sale services directly from the united states, including a qualified and highly professional technical support service with longstanding experience in the glass-working machine industry.

100+

Countries where  
Lattuada machines are  
installed

90+

Countries where  
we are present

40+

Agents worldwide

Adelio Lattuada Srl assumes no responsibility for any mistakes in the contents.  
All data are subject to change without notice.  
Images can be only representative of the products' typology.



**ADELIO LATTUADA S.R.L.**  
Via Abbondanza, 11/13 - 22070 Carbonate (CO) IT  
T. +39 0331.832713 - info@adeliolattuada.com  
[adeliolattuada.com](http://adeliolattuada.com)

**LATTUADA NORTH AMERICA, INC.**  
6967 Wales Road, Suite F - Northwood 43619 (OH)  
T. 567 249 4486 - info@lattuada-na.com  
[lattuada-na.com](http://lattuada-na.com)