

GRINDING

SOLUTIONS



EDGING MACHINES
BEVELLING MACHINES



LATTUADA
+ADDING VALUE

STRAIGHT-LINE **EDGING MACHINES**



AL M SERIES

Recommended even for large-scale production of medium thickness sheets

18



TL SERIES

Recommended for large scale production of tempered glass and/or high-quality furnishing glass

24



TLR SERIES

The most widely used by major manufacturers of stratified material for heavy duty construction

30



TLS SERIES

Recommended for glassmakers with considerable production of large sheets and high thicknesses

38

STRAIGHT-LINE **BEVELLING MACHINES**



GAMMA SERIES

The widest range currently available in the market, it offers technical solutions capable of meeting any production need

48

ADDING VALUE

THE INESTIMABLE VALUE OF GIVING AND RECEIVING

THE VALUE RECEIVED

Every person who has trusted Lattuada has enriched its story. Each glass (or stone) processing solution completed and put into production has added even more experience and drive.

THE VALUE OFFERED

Building on many years of market knowledge and a vast portfolio of successful projects, Lattuada continues to invest in development, research and training. With continually updated internal and external feedback, it strives to offer more quality, more solutions, more technology.

ADDING + VALUE

A SYNERGY OF VALUES CALLED A COMPANY

Quality and personalisation

Are the hallmark of Lattuada's design. Attention to every detail is pursued within a customised production process, with care and attention.

Flexibility and assistance

Maximum willingness to listen and develop the client's requests. Guarantee of follow-up and further customisation throughout the machine life cycle.

History and experience

Since 1978, day after day, milestone after milestone, Lattuada has continued to grow in its problem-solving capacity and in guaranteeing progressive know-how to all its customers.

Internationality and italianity

Made in Italy represents worldwide excellence in the glass sector. The sense of belonging coexists with the pride of constantly interacting with an international audience.

Innovation and substance

Proposing new solutions is part of Lattuada's DNA. Simplification, training and constant support are the pluses offered to combine technology and user-friendliness.

Eco-Sustainability and territory

Starting from the Italian headquarters, concrete actions for the environment have been undertaken for years. Likewise, Lattuada's solutions will be increasingly 'green'.

AS BIG AS THE WORLD.



HEADQUARTER



NORTHWOOD (OH)
A PRECISE CORPORATE
CHOICE TO STAY CLOSE
TO OUR CUSTOMERS

LLNA provides all pre- and after-sale services directly from the United States, including a qualified and highly professional technical support service with longstanding experience in the glass-working machine industry.

OUR SOLUTIONS ARE WORKING ALL OVER THE WORLD.
SINCE 2017 WE OPERATE IN THE USA THROUGH LATTUADA
NORTH AMERICA BASED IN NORTHWOOD (OHIO).
A PRECISE CORPORATE CHOICE TO STAY CLOSE TO OUR
CUSTOMERS BY OFFERING TOP QUALITY SERVICES AND
PRODUCTS SPECIFICALLY DESIGNED FOR A DEMANDING
AND COMPETITIVE MARKET THAT REQUIRES COMPLIANCE
TO SPECIFIC STANDARDS.



1.00+

Countries where
Lattuada machines
are installed

90+

Countries where
we are present

40+

Agents worldwide

This new company allows us to offer endless
benefits to all our US customers:

- no more problems related to transportation issues;
- machinery are invoiced directly from the United States,
eliminating the currency problem;
- specific services for the US market;
- technical support always available with
no more time zone issues;
- spare parts are supplied directly from
LATTUADA NORTH AMERICA.

integrAL

ADDING VALUES FOR INTEGRAL SOLUTIONS

INTEGRAL IS LATTUADA'S COMBINATION OF PRODUCTS, SERVICES AND TECHNOLOGY TO OFFER A SINGLE, CENTRALISED MANAGEMENT IN GLASS AND STONE PROCESSING.



SPECIAL MACHINES SOLUTIONS

Do you have any special needs?
Out-of-standard processes?
Do you treat composite materials?
That's not a problem.
We can find the most suitable solution for you and customise our machines to ensure you get the flexibility you need.



STONE SOLUTIONS

Lattuada's many years of know-how transferred to natural stone, ceramic and composite material processing: PetrA, vertical edge polisher - Works with precision and quality on all types of edges, and, thanks to its natural versatility, is perfect for Stone Professionals production facilities.

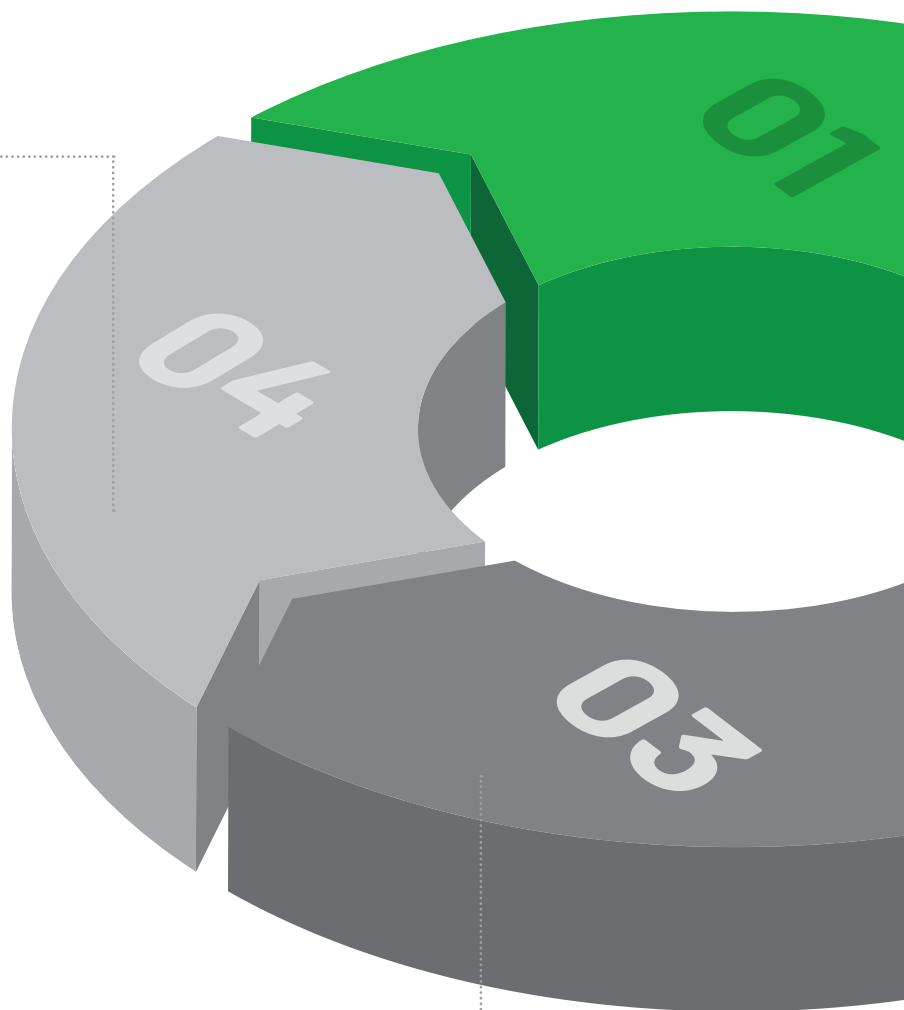



GLASS SOLUTIONS

Customisation, precision, versatility: all of Lattuada glass processing lines ensure excellent performance and high productivity, integrating perfectly into company realities. A combination of experience and innovation to meet any kind of challenge.



> Grinding

Our strength, always. A variety of solutions taking the shape of a wide range of machines: more than 40 models that can be specifically configured to ensure maximum productivity.



> Washing

For more than 15 years we have been studying and providing solutions for glass washing. We offer a full range of high-tech, vertical washing machines that are easy to use and maintain.



> Complementary processing

Do you need to drill or process corners? We can provide a complete range of horizontal drilling machines and automatic radius and straight corners grinding machines.



AUTOMATION SOLUTIONS

Robotics, A-WR & i-AL Systems, Augmented Reality and IoT: a beating heart of innovation and technology revolutionising glass and stone processing. Lattuada Automation Solutions bring companies into the world of Industry 4.0, by making every machine a concentrate of precision, productivity and automation.

“ Made in Lattuada integrated solutions, to meet all your needs ”

AUTOMATIC MACHINES
A-WR & i-AL Systems
ROBOTIC SOLUTIONS
AR ASSISTANCE
IOT

AUTO MATION SOLUTIONS

EVERY CUSTOMER
IS UNIQUE TO US...
AS UNIQUE AS
OUR SOLUTIONS

Robotics, A-WR & i-AL Systems, Augmented Reality and IoT: a beating heart of innovation and technology revolutionising glass and stone processing.

Lattuada brings companies into the world of Industry 4.0, by making every machine a concentrate of precision, productivity and automation.

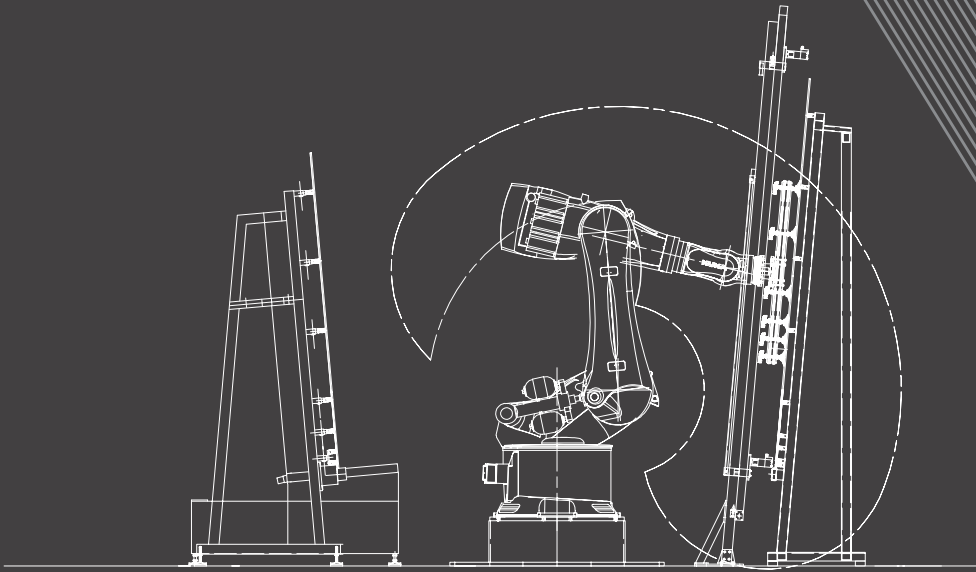

KNOW-HOW

We are your partner in automation.

For more than 5 years we have dedicated internal resources and major investments in designing and building solutions that integrate robots and automation to support our glass processing machines. Thanks to synergies with integrators with a decade of experience, we are in a position to offer up to date and world-class know-how and skills.



CONSULTANCY

Beyond the offer, consultancy.

A single global consultant partner for your current and future needs. Thanks to a powerful simulation software, we can key in standard production data and values of your workday and compare them with those obtained from a presumed use of robots. This way, you can notice the difference and thus make the decision that best fits your efficiency and productivity boost needs.



ASSISTANCE

Training and technical support, wherever you are.

Our teams are ready to give you appropriate training and technical support you may need, through our hotlines. Whether regarding the machine or the applications, you have a far-reaching network of agents and dealers at your disposal in every corner of the globe. As concerns robots, they require minimum maintenance considering their high and constant performance.



SKILLS

One application, one solution.

Thanks to world-class collaborations and supplies, our solutions gain in effectiveness and efficiency year by year. This contributes towards developing know-how and skills assets like few others can worldwide, keeping one guaranteed focus: building applications that are not only easy to implement and use, but that can also keep production performance constant over time.



SMARTNESS

Customised and smart machines.

Our machines have always been custom-built. With forty years of experience in the industry, we - at Adelio Lattuada - can modify configuration to meet your production needs. But that alone is not enough. We are committed towards making machines more automated and smarter by installing state of the art devices and sensors.



INTEGRATION

More targeted than ever before.

The more machines are integrated with each other through specially studied software, the greater their efficiency and productivity. We are working on getting rid of repetitive manuals and combining control operations: we aim at creating a system where machines can communicate with each other and can make autonomous decisions to maintain high production and safety level, eliminating errors.

A PERFECT SYNERGY
WITH TECHNOLOGY

ROBOTS

New integrated, **flexible and customised solutions** with the following advantages

01 CUSTOMISABLE SUCTION CUPS
vacuum with Venturi system

03 AUTOMATIC MEASUREMENT OF GLASS
pre-setting glass size is not required

05 AUTOMATIC SPEED ADJUSTMENT
depending on the sizes of the glass

07 HIGHER PRODUCTIVITY
thanks to the high speed of this system

09 OPTION OF INTEGRATION
with other machines

02 HIGH FLEXIBILITY
side by side processing of glasses of different sizes with minimum distance between them

04 EASE OF USE
straight-line edging machines with standard maintenance

06 LOWER COSTS
just one operator required

08 FULLY AUTOMATION OF MACHINES
reducing the need to access to the area, safety and productivity increase

10 CONTINUITY ASSURED
thanks to the low maintenance required by our machines

Different configurations available for the implementation in several applications:

2 EDGERS AND 1 ROBOT

The most sold

*** 2 EDGERS AND 2/3 ROBOTS**

For fully automated cells

1 EDGER AND 1 ROBOT

Fully automated cell in a reduced space

4 EDGERS AND 3 ROBOTS

Special solutions

INTEGRATION

With washers, CNCs, double-edgers, cutting, tempering or IG lines, etc.

* 2 edgers and 2/3 robots

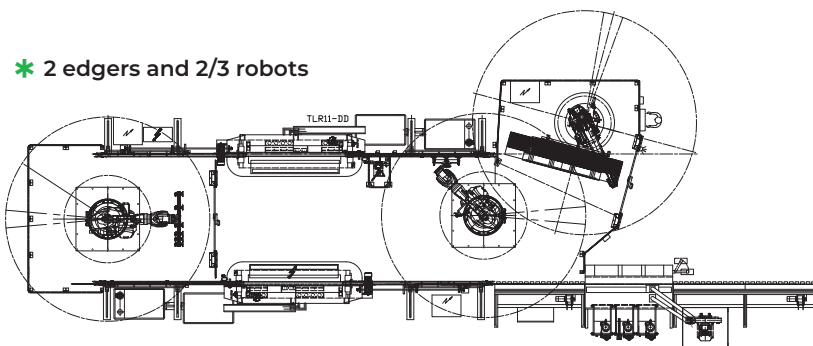

In partnership with:



AUTOMATIC MACHINES

Solutions for automating activities and increasing production flexibility

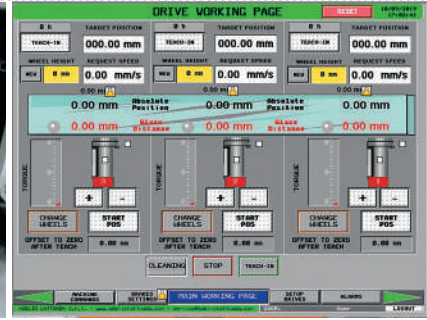

A-WR SYSTEM

Introduces a completely automatic wheels setting management.



i-AL

A comprehensive pack of mechanical, electronic and software systems especially designed to deliver the maximum possible automation in glass processing and a full integration with your entire production system.

INDUSTRY 4.0

SOLUTIONS FOR TRANSFORMING PRODUCTION AND BECOMING A SMART FACTORY

Industry 4.0 has already become an active part of many companies, becoming a strong competitive factor. An approach that deeply changes the production process by implementing enabling technologies: a leap you can already take into the future through **Adelio Lattuada** products.

As a matter of fact, thanks to the **PLM IOT i-Like Machines software**, besides connecting machines to each other so as to monitor them constantly, we also provide clear data through an interface that is intuitive and easy to use.

THE WIDEST LINE AVAILABLE IN THE MARKET

GRINDING SOLUTIONS

- > STRAIGHT-LINE EDGING MACHINES
- > STRAIGHT-LINE BEVELLING MACHINES



performing

high loading capacity,
jumbo thicknesses

Our machines can carry sheets weighing up to 1,500 Kg and machine thicknesses measuring up to 100 mm.



productive

smart technology

Automation is an ever-important factor: combining the need for providing high-quality products, without jeopardising flexibility while increasing productivity and cutting costs all at once.



reliable

low maintenance required

We commit towards achieving excellence by making precise choices: saying no to makeshift solutions. We have set up an internal and external supply chain that ensures the highest standards of reliability.



As our core business since our foundation, the Lattuada's offering includes more than 40 models of **straight-line edging machines, double-edgers** - which come in several different configurations - **and straight-line bevelling machines** suitable to meet any production need.



flexible

customised configurations

Our machines are custom-made, to give you more. Consisting of an excellent base structure, they can be configured to meet your needs.



smart

simplicity of use

Easily accessible sophisticated technology: this is our approach when it comes to building machines.



excellent

top performance

Thanks to our know-how developed and perfected in 40 years of research and activity in grinding, we - at Lattuada - design and manufacture machines that guarantee maximum processing end quality.

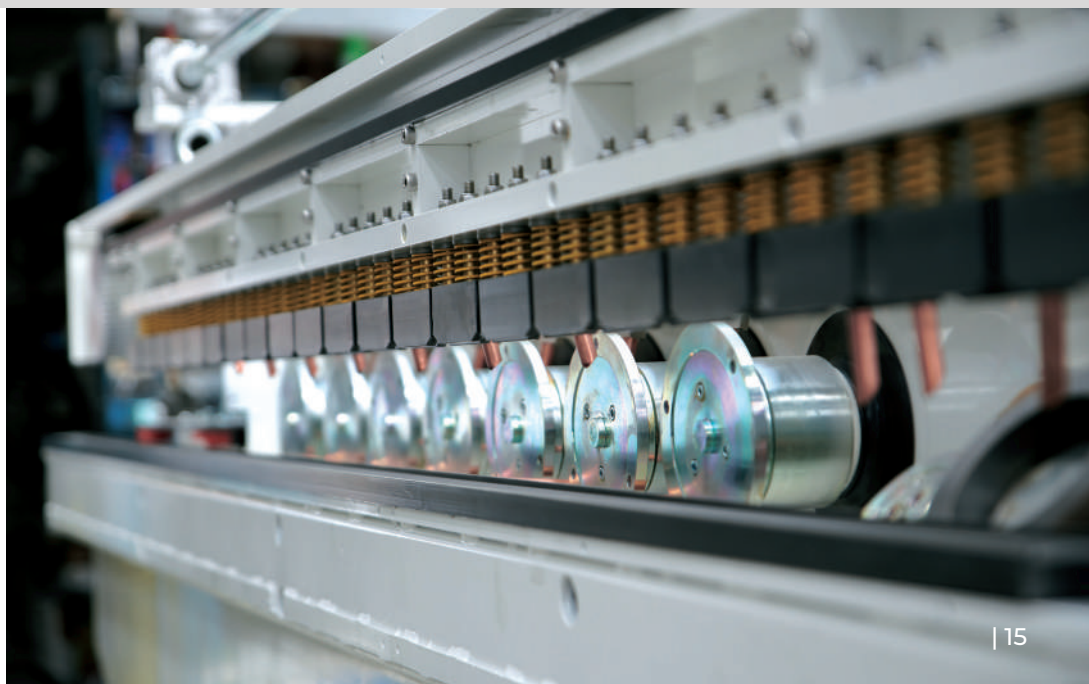

STRAIGHT-LINE EDGING MACHINES

TECHNICAL DETAILS

Our strength, ever.

A variety of solutions that take the form of a wide range of machines: **more than 40 models that can be specifically configured to ensure maximum productivity.**

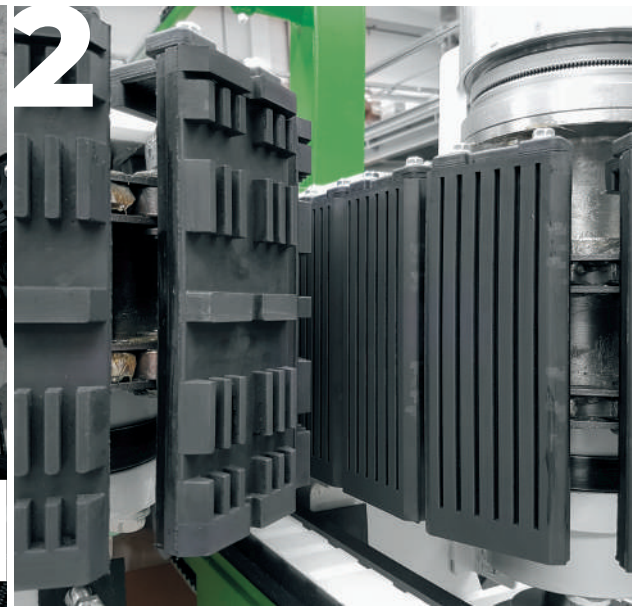
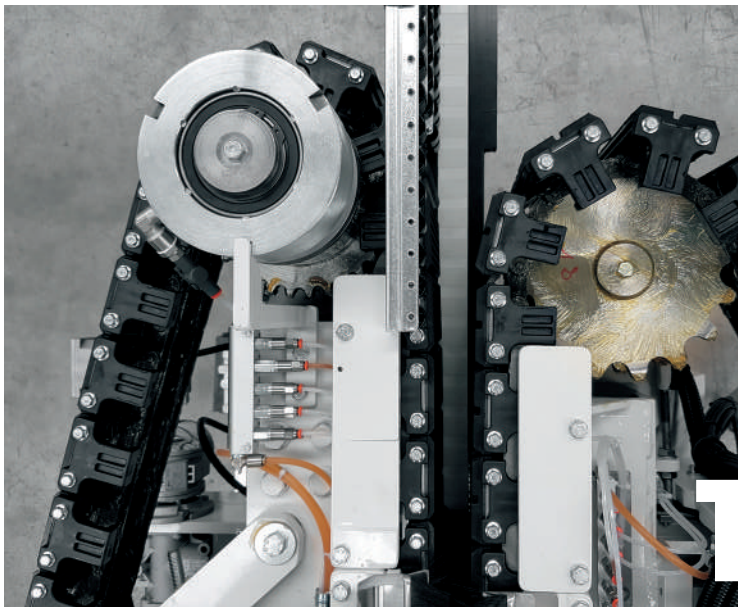

1-2 **Conveyor** with support pads.

3-4 Automatic **lubrication system**.

5-6 **Lattuada spindles**: a unique solution for the motion transmission.

7-8 **Copper pipes for cooling the wheels** and the internal of the spindle tank.

9-10 **Electrical system** with supreme quality components, compliant with the **UL/CSA standards** too. **IE3 high efficiency motors**.

11 **Digital ammeters** with an automatic polishing wheels wear detection system.

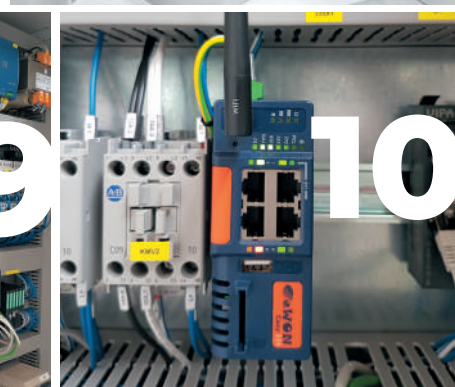
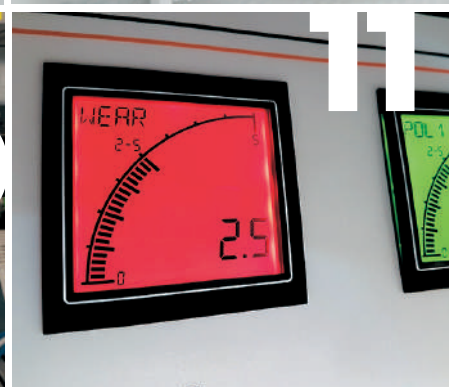
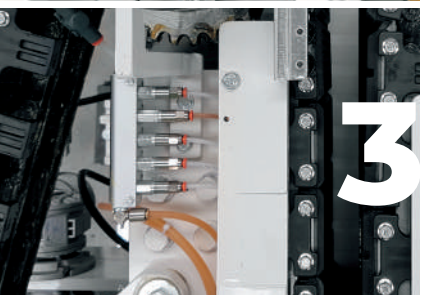
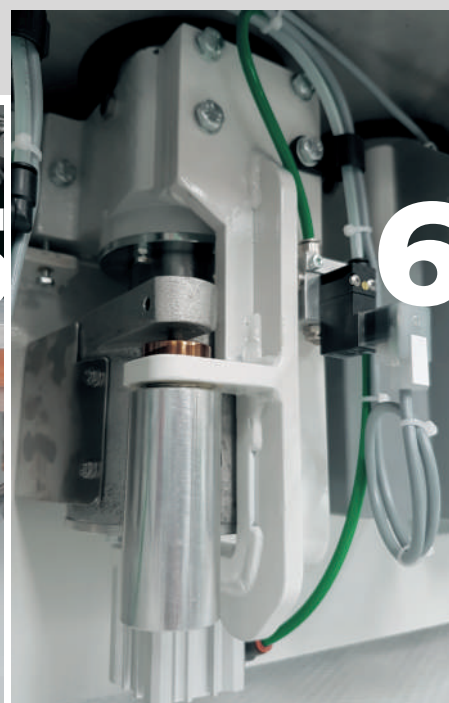
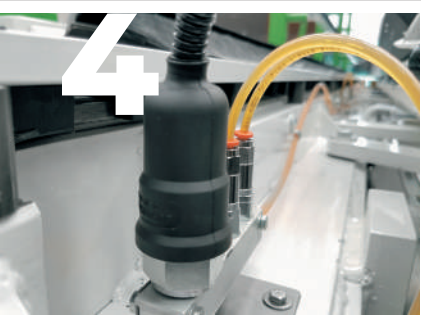

ALM SERIES

RECOMMENDED EVEN FOR LARGE-SCALE PRODUCTION OF MEDIUM THICKNESS SHEETS

Having been conceived and manufactured using some of the technological solutions adopted for the larger series of edging machines, such as the assembly of the same spindles, AL M edging machines can handle high production levels.

These details contribute towards increasing their useful life, while simultaneously reducing the required maintenance.



3 - 20/25 mm
1/8 - 3/4 /1"



2000 mm
78.7 "

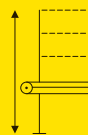

2400 - 3000 mm
94.5 - 118.1 "



400 Kg - 200 Kg/m
881 lbs - 11.2 lbs/ "



700 Kg
1,543 lbs

STRAIGHT-LINE EDGING MACHINES AL M SERIES

ALL YOU NEED TO KNOW

How flexible and modular are they?

- Possibility to mount a resin wheel spindle
- Possibility to integrate the OT 300 washing machine model

Which are the processing control tools?

- Electric board integrated in the control panel
- Motor current absorption ammeter
- Removal adjustment on the inlet conveyor
- Machine's data and maintenance panel

Which components of the machine allow achieving high performance?

- Conveyor without bearing, consisting of pads of a special material, fixed on precision chains
- Mechanical system for adjusting the opening of the conveyor
- Variation of the conveyor speed by means of the inverter
- Automatic lubrication of all rotating parts

How can I achieve higher quality?

- Liquid cerium oxide for greater processing quality
- Lattuada spindles: a unique solution that guarantees low vibrations, robustness and limits maintenance for supreme quality



AL M SERIES

THE FLEET



AL M SERIES



Electronic straight-line edging machines
for processing the **flat edge with arris**



AL T SERIES



Peripheral straight-line edging machines for processing the **pencil edge, OG or flat edge with arris**

ALM SERIES

Electronic straight-line edging machines
for processing the **flat edge with arris**



AL 6 M	eu	0,5 - 4 m/min	H50 mm opt. H35 mm	3 - 20 mm	12,5	5.755x1.450 xH2.400 mm	2.000 Kg	400 Kg - 200 Kg/m	700 Kg
	us	20 - 157 "/min	H2 " opt. H1.4 "	1/8 - 3/4 "		226.5x57 xH94.5 "	4,409 lbs	881 lbs - 11.2 lbs/"	1,543 lbs

AL 8 M	eu	0,5 - 4 m/min	H50 mm opt. H35 mm	3 - 25 mm	15	6.285x1.450 xH3.000 mm	2.200 Kg	400 Kg - 200 Kg/m	700 Kg
	us	20 - 157 "/min	H2 " opt. H1.4 "	1/8 - 1 "		247.4x57 xH118.1 "	4,850 lbs	881 lbs - 11.2 lbs/"	1,543 lbs

AL 9 M	eu	0,5 - 4 m/min	H50 mm opt. H35 mm	3 - 25 mm	17	6.285x1.450 xH3.000 mm	2.400 Kg	400 Kg - 200 Kg/m	700 Kg
	us	20 - 157 "/min	H2 " opt. H1.4 "	1/8 - 1 "		247.4x57 xH118.1 "	5,291 lbs	881 lbs - 11.2 lbs/"	1,543 lbs

LEGEND

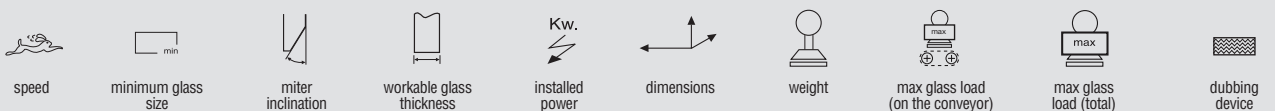

ALT SERIES

Peripheral straight-line edging machines for processing the **pencil edge, OG or flat edge with arris**

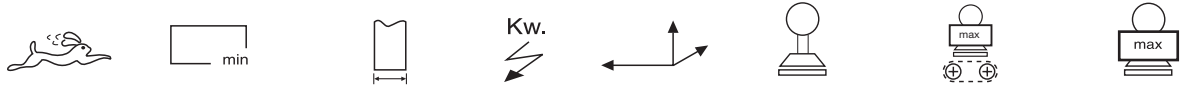

AL 4 T	eu	0,5 - 4 m/min	H50 mm opt. H35 mm	3 - 20 mm	10	6.100x1.465 xH2.400 mm	2.200 Kg	400 Kg -200 Kg/m	700 Kg		
	us	20 - 157 "/min	H2 " opt. H1.4 "	1/8 - 3/4 "		240.2x57.6 xH94.5 "	4,850 lbs	881 lbs - 11.2 lbs/"	1,543 lbs		
								4	3	2	1

AL 6 T	eu	0,5 - 4 m/min	H50 mm opt. H35 mm	3 - 20 mm	12,5	6.440x1.465 xH2.400 mm	2.200 Kg	400 Kg -200 Kg/m	700 Kg				
	us	20 - 157 "/min	H2 " opt. H1.4 "	1/8 - 3/4 "		253.5x57.6 xH94.5 "	4,850 lbs	881 lbs - 11.2 lbs/"	1,543 lbs				
								6	5	4	3	2	1



TL SERIES

**RECOMMENDED FOR LARGE SCALE
PRODUCTION OF TEMPERED GLASS
AND/OR HIGH-QUALITY FURNISHING GLASS**

Thanks to the reinforced guides and higher pads, TL edging machines can bear greater weight as compared to the previous series. This makes them particularly flexible, given that they can process from glass sheets featuring major thicknesses to small glass strips, up to a minimum of 35 mm in height.



3 - 30 / 35 mm
1/8 - 1.2 / 1.4 "



2600 mm
102.4 "

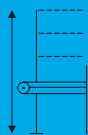

3100 mm
122 "



800 Kg - 250 Kg/m
1,763 lbs - 14 lbs/ "



1,600 Kg
3,527 lbs

STRAIGHT-LINE EDGING MACHINES TL SERIES

ALL YOU NEED TO KNOW

How flexible and modular are they?

- Possibility to integrate the OT 300 washing machine model
- Front adjustment of the rear arris
- Dubbing device

Which are the processing control tools?

- Motor current absorption ammeter
- Removal adjustment on the inlet conveyor
- Machine's data and maintenance panel, greater and with more functions

Which components of the machine allow achieving high performance?

- Conveyor without bearing, consisting of pads made of special material, fixed on a double precision chain
- Mechanical system for adjusting the opening of the conveyor
- Variation of the conveyor speed by means of the inverter
- Automatic lubrication of all rotating parts
- Inlet and outlet conveyor pneumatic clutch
- Longer pads for greater stability of the glass
- Oil system with end of line pressure switch

How can I achieve higher quality?

- Liquid cerium oxide for greater processing quality
- Lattuada spindles: a unique solution that guarantees low vibrations, robustness and limits maintenance for supreme quality
- Possibility to mount a resin wheel spindle

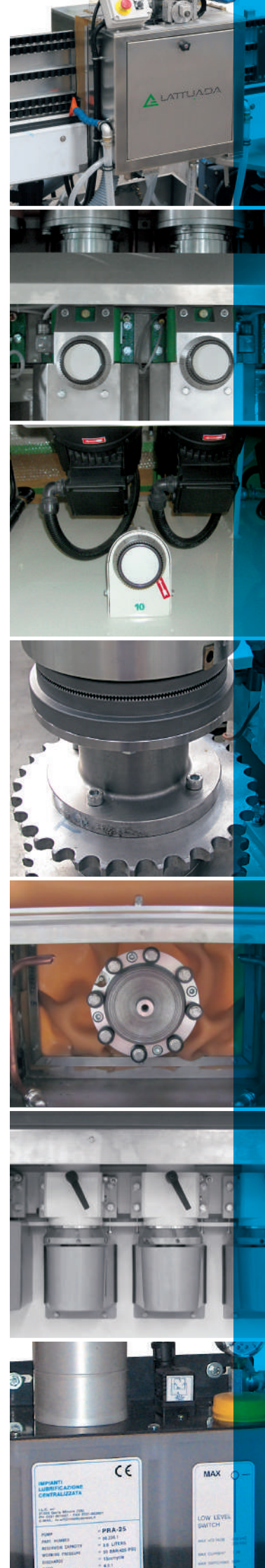

TL SERIES

THE FLEET

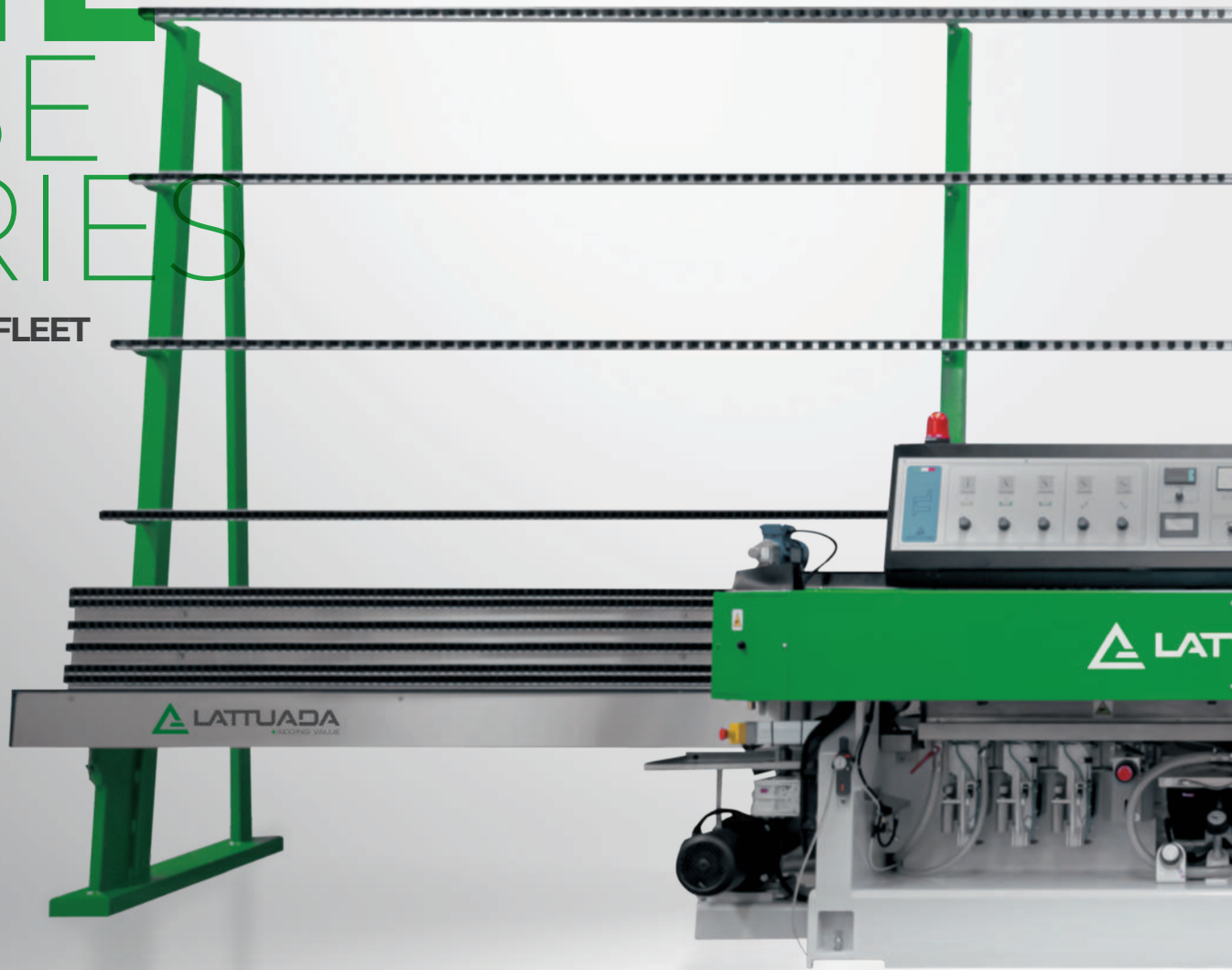

TL SERIES



Electronic straight-line edging machines
for processing the **flat edge with arris**



TL AV SERIES



Electronic straight-line edging machine
with **variable angle between 0 and 45°**

TL SERIES

Electronic straight-line edging machines
for processing the **flat edge with arris**

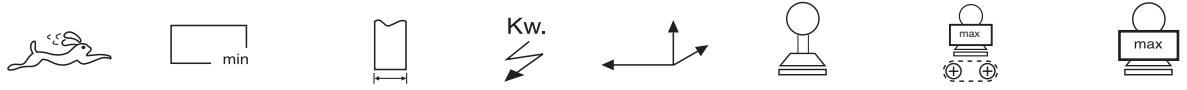

TL 10 PC	eu	0,3 - 5 m/min	H60 mm opt. H35 mm	3 - 30 mm opt. 3 - 35 mm	20	7.730x1.600 xH3.100 mm	3.100 Kg	800 Kg - 250 Kg/m	1.600 Kg	
	us	12 - 197 "/min	H2.4 " opt. 1.4 "	1/8 - 1.2 " opt. 1/8 - 1.4 "		304.3x62.2 xH122 "	6,834 lbs	1,763 lbs - 14 lbs/'	3,527 lbs	
		3* OPTIONAL								

TL 10 C PC	eu	0,3 - 5 m/min	H60 mm opt. H35 mm	3 - 30 mm opt. 3 - 35 mm	21	7.970x1.600 xH3.100 mm	3.100 Kg	800 Kg - 250 Kg/m	1.600 Kg	
	us	12 - 197 "/min	H2.4 " opt. 1.4 "	1/8 - 1.2 " opt. 1/8 - 1.4 "		313.7x62.2 xH122 "	6,834 lbs	1,763 lbs - 14 lbs/'	3,527 lbs	
		3* OPTIONAL								

TL 11 PC	eu	0,3 - 5 m/min	H60 mm opt. H35 mm	3 - 30 mm opt. 3 - 35 mm	22	7.970x1.600 xH3.100 mm	3.100 Kg	800 Kg - 250 Kg/m	1.600 Kg	
	us	12 - 197 "/min	H2.4 " opt. 1.4 "	1/8 - 1.2 " opt. 1/8 - 1.4 "		313.7x62.2 xH122 "	6,834 lbs	1,763 lbs - 14 lbs/'	3,527 lbs	
		3* OPTIONAL								



LEGEND

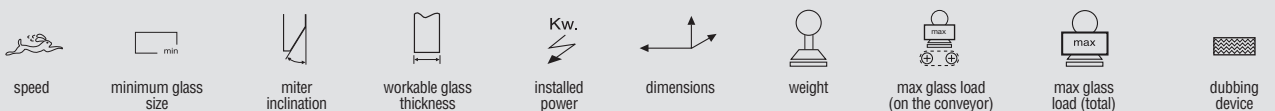

TLAV SERIES

Electronic straight-line edging machine with **variable angle between 0 and 45°**



TL 9 AV PC	eu	0,3 - 5 m/min	H85 mm opt. H60 mm	0 - 45° opt. 0 - 60°	3 - 30 mm opt. 3 - 35 mm	21	7.970x1.600 xH3.100 mm	3.800 Kg	800 Kg - 250 Kg/m	1.600 Kg						
	us	12 - 197 "/min	H3.3 " opt. H2.4 "		1/8 - 1.2 " opt. 1/8 - 1.4 "		313.7x62.2 xH122 "	8,377 lbs	1,763 lbs - 14 lbs/"	3,527 lbs						
							9	8	7	6	5	4	3	2	1	



- diamond peripheral wheel
- peripheral polishing wheel
- diamond cup wheel
- resin cup wheel
- polishing cup wheel
- cerium impregnated cup wheel
- felt cup wheel
- polishing aris wheel
- diamond aris wheel
- felt aris wheel

TIR

SERIES

THE MOST WIDELY USED BY
MAJOR GROUPS OF NORTHERN
EUROPE AND USA

Designed for glassmakers handling major volumes of large sheets and high thicknesses for heavy duty construction, or for supreme quality works at high speed.



3 - 40 / 50 / 55 mm
1/8 - 1.5 / 2 / 2.2 "

2.600 mm / 3.000 mm
102.3 / 118.1 "

3.100 mm / 3.700 mm
122 / 145.6 "

1.100 Kg - 350 Kg/m
2,425 lbs - 19.6 lbs/ "

2.000 Kg
4,409 lbs

STRAIGHT-LINE EDGING MACHINES TLR SERIES

ALL YOU NEED TO KNOW

How flexible and modular are they?

- Possibility to mount a resin wheel spindle
- Possibility to integrate the OT 300 washing machine model
- Brushes for washing the conveyor

Which are the processing control tools?

- Digital ammeters with an automatic system for detecting the wear of polishing wheels
- Removal adjustment on the inlet conveyor
- Machine's data and maintenance panel, greater and with more functions
- Glass detection IP67 ultrasonic sensor
- Inlet and outlet conveyor pneumatic clutch

Which components of the machine allow achieving high performance?

- Conveyor without bearing, consisting of pads made of special material, fixed on a double precision chain
- Mechanical system for adjusting the opening of the conveyor
- Variation of the conveyor speed by means of the inverter
- Automatic lubrication of all rotating parts
- Oil system with end of line pressure switch
- PAR-AL: device for processing parallelograms

How can I achieve higher quality?

- Liquid cerium oxide for greater processing quality
- Lattuada spindles: a unique solution that guarantees low vibrations, robustness and limits maintenance for supreme quality
- Up to 9 wheels in the mitering section for processing big miters

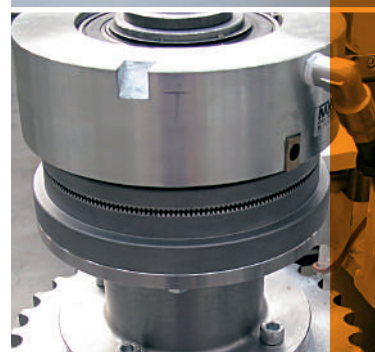
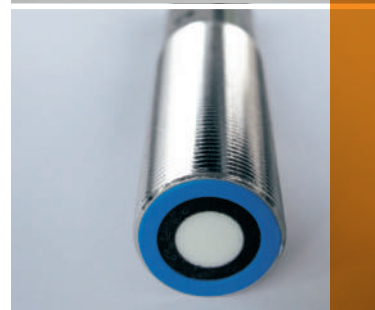
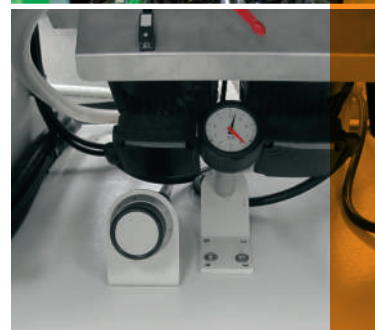
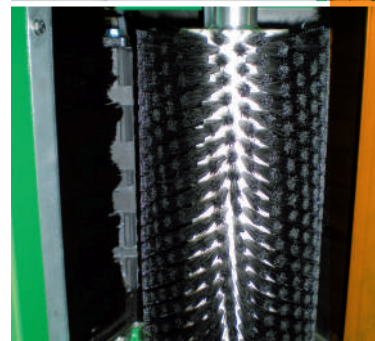
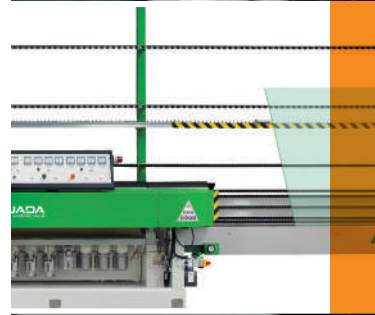

TLR

SERIES

THE FLEET



TLR SERIES



Electronic straight-line edging machines
for processing the **flat edge with arris**



TLR AV SERIES



Electronic straight-line edging machine
with **variable angle between 0 and 45°**

TLR SERIES

Electronic straight-line edging machines
for processing the **flat edge with arris**

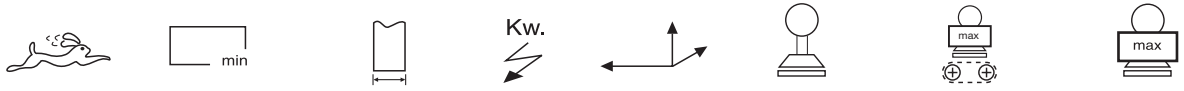

TLR 11 PC	eu	0,3 - 5 m/min	H60 mm opt. H35 mm	3 - 40 mm opt. 3 - 50 mm	22	8.210x1.1600 xH3.100 mm	3.100 Kg	1.100 Kg - 350 Kg/m	2.000 Kg						
	us	12 - 197 "/min	H2.4 " opt. 1.4 "	1/8 - 1.5 " opt. 1/8 - 2 "		323.2x62.2 xH122 "	6,834 lbs	2,425 lbs - 19.6 lbs/"	4,409 lbs						
						11	10	9	8	7	6	5	4	3	2

TLR 11 C PC	eu	0,3 - 5 m/min	H60 mm opt. H35 mm	3 - 40 mm opt. 3 - 50 mm	22	8.210x1.600 xH3.100 mm	3.100 Kg	1.100 Kg - 350 Kg/m	2.000 Kg						
	us	12 - 197 "/min	H2.4 " opt. 1.4 "	1/8 - 1.5 " opt. 1/8 - 2 "		323.2x62.2 xH122 "	6,834 lbs	2,425 lbs - 19.6 lbs/"	4,409 lbs						
						11	10	9	8	7	6	5	4	3	2

TLR 11 DD PC	eu	0,3 - 5 m/min*	H60 mm	3 - 50 mm**	22	8.510x1.600 xH3.100 mm	4.000 Kg	1.100 Kg - 350 Kg/m	2.000 Kg											
	us	12 - 197 "/min*	H2.4 "	opt. 1/8 - 2 ***		335x62.2 xH122 "	8,818 lbs	2,425 lbs - 19.6 lbs/"	4,409 lbs											
			* max 3,5 m/min (max 137 "/min) (with dubbing device) ** max 15 mm (max 0.6 ") (with dubbing device)							12	11	10	9	8	7	6	5	4	3	2

LEGEND

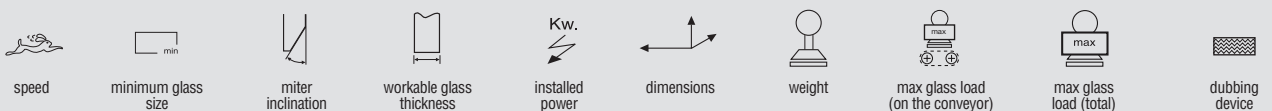

TLR SERIES

Electronic straight-line edging machines
for processing the **flat edge with arris**



TLR 12 C PC	eu	0,3 - 5 m/min	H60 mm opt. H35 mm	3 - 50 mm	23	8.510x1.600 xH3.100 mm	4.000 Kg	1.100 Kg - 350 Kg/m	2.000 Kg
	us	12 - 197 "/min	H2.4 " opt. 1.4 "	1/8 - 2 "		335x62.2 xH122 "	8,818 lbs	2,425 lbs - 19.6 lbs/"	4,409 lbs
OPTIONAL									

TLR 13 PC	eu	0,3 - 5 m/min	H60 mm opt. H35 mm	3 - 50 mm	28	8.510x1.600 xH3.100 mm	4.000 Kg	1.100 Kg - 350 Kg/m	2.000 Kg
	us	12 - 197 "/min	H2.4 " opt. 1.4 "	1/8 - 2 "		335x62.2 xH122 "	8,818 lbs	2,425 lbs - 19.6 lbs/"	4,409 lbs

TLR 13 C PC	eu	0,3 - 5 m/min	H60 mm opt. H35 mm	3 - 55 mm	28	9.590x1.600 xH3.700 mm	4.600 Kg	1.100 Kg - 350 Kg/m	2.000 Kg
	us	12 - 197 "/min	H2.4 " opt. 1.4 "	1/8 - 2.2 "		377.5x62.2 xH145.6 "	10,141 lbs	2,425 lbs - 19.6 lbs/"	4,409 lbs

TLR 14 C PC	eu	0,3 - 5 m/min	H60 mm opt. H35 mm	3 - 55 mm	30	9.590x1.600 xH3.700 mm	4.800 Kg	1.100 Kg - 350 Kg/m	2.000 Kg
	us	12 - 197 "/min	H2.4 " opt. 1.4 "	1/8 - 2.2 "		377.5x62.2 xH145.6 "	10,582 lbs	2,425 lbs - 19.6 lbs/"	4,409 lbs

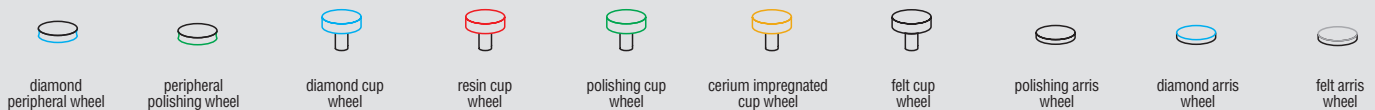

TLR AV SERIES

Electronic straight-line edging machine
with **variable angle between 0 and 45°**

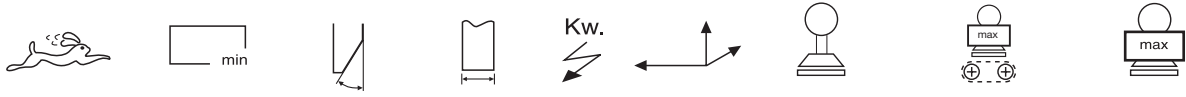

TLR 10 AV PC	eu	0,3 - 5 m/min	H85 mm opt. H60 mm	0 - 45° opt. 0 - 60°	3 - 40 mm opt. 3 - 50 mm	23	8.510x1.600 xH3.100 mm	4.000 Kg	1.100 Kg - 350 Kg/m	2.000 Kg
	us	12 - 197 "/min	H3.3 " opt. H2.4 "		1/8 - 1.5 " opt. 1/8 - 2 "		335x62.2 xH122 "	8,818 lbs	2,425 lbs - 19.6 lbs/"	4,409 lbs

TLR 11 AV PC	eu	0,3 - 5 m/min	H85 mm opt. H60 mm	0 - 45° opt. 0 - 60°	3 - 50 mm	23	8.510x1.600 xH3.100 mm	4.200 Kg	1.100 Kg - 350 Kg/m	2.000 Kg
	us	12 - 197 "/min	H3.3 " opt. H2.4 "		1/8 - 2 "		335x62.2 xH122 "	9,259 lbs	2,425 lbs - 19.6 lbs/"	4,409 lbs

TLR 11 AV C PC	eu	0,3 - 5 m/min	H85 mm opt. H60 mm	0 - 45° opt. 0 - 60°	3 - 50 mm	23	8.500x1.600 xH3.100 mm	4.200 Kg	1.100 Kg - 350 Kg/m	2.000 Kg
	us	12 - 197 "/min	H3.3 " opt. H2.4 "		1/8 - 2 "		335x62.2 xH122 "	9,259 lbs	2,425 lbs - 19.6 lbs/"	4,409 lbs

LEGEND

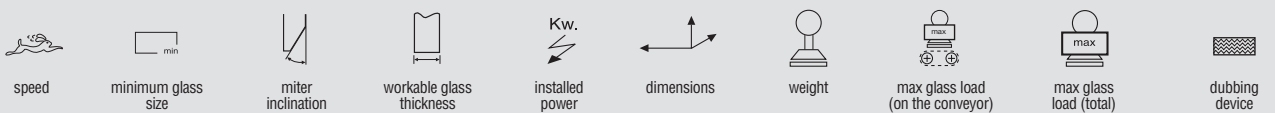

TLR AV SERIES

Electronic straight-line edging machine with **variable angle between 0 and 45°**



TLR 11 AV C DD PC	eu	0,3 - 5 m/min*	H85 mm	0 - 45°	3-50 mm**	25	8.970x1.600 xH3.100 mm	4.800 Kg	1.100 Kg - 350 Kg/m	2.000 Kg
	us	12 - 197 "/min*	H3.3 "		1/8 - 2 ***		353.1x62.2 xH122 "	10,582 lbs	2,425 lbs - 19.6 lbs/"	4,409 lbs
			* max 3,5 m/min (max 137 "/min) (with dubbing device) ** max 15 mm (max 0.6 ") (with dubbing device)							

TLR 13 AV C PC	eu	0,3 - 5 m/min	H85 mm opt. H60 mm	0 - 45°	3-55 mm	28	9.590x1.600 xH3.700 mm	4.800 Kg	1.100 Kg - 350 Kg/m	2.000 Kg
	us	12 - 197 "/min	H3.3 " opt. H2.4 "		1/8 - 2.2 "		377.6x62.2 xH145.6 "	10,582 lbs	2,425 lbs - 19.6 lbs/"	4,409 lbs

TLR 14 AV C PC	eu	0,3 - 5 m/min	H85 mm opt. H60 mm	0 - 45°	3 - 55 mm	30	10.020x1.600 xH3.700 mm	5.700 Kg	1.100 Kg - 350 Kg/m	2.000 Kg
	us	12 - 197 "/min	H3.3 " opt. H2.4 "		1/8 - 2.2 "		394.5x62.2 xH145.6 "	12,566 lbs	2,425 lbs - 19.6 lbs/"	4,409 lbs

TLR 16 AV C PC	eu	0,3 - 5 m/min	H85 mm opt. H60 mm	0 - 45°	3 - 55 mm	34	10.370x1.600 xH3.700 mm	6.800 Kg	1.100 Kg - 350 Kg/m	2.000 Kg
	us	12 - 197 "/min	H3.3 " opt. H2.4 "		1/8 - 2.2 "		408.3x62.2 xH145.6 "	14,991 lbs	2,425 lbs - 19.6 lbs/"	4,409 lbs

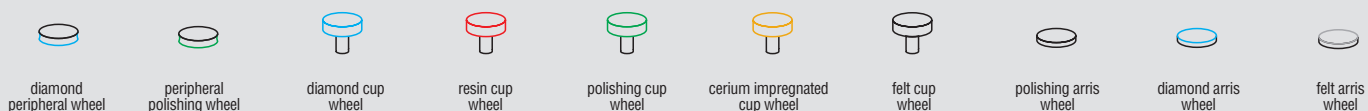

TLS SERIES

**THE EVOLUTION OF OUR FAMILY
OF TLR EDGING MACHINES.**

Thanks to some structural changes, mainly due to the application of new pads and reinforced guides, the models of this series are capable of carrying sheets weighing up to 1,500 Kg (on the conveyor) and processing sheets with thickness up to 100 mm.



3 - 60 / 80 / 100 mm
1/8 - 2.4 / 3.1 / 3.9 "



3,000 mm
118.1 "



3,700 mm
145.6 "



1,100 Kg - 350 Kg/m
2,425 lbs - 19.6 lbs/"



2,200 Kg
4,850 lbs

STRAIGHT-LINE EDGING MACHINES TLS SERIES

ALL YOU NEED TO KNOW

How flexible and modular are they?

- Possibility to mount a resin wheel spindle
- Possibility to integrate the OT 300 washing machine model

Which are the processing control tools?

- Digital ammeters with an automatic system for detecting the wear of polishing wheels
- Removal adjustment on the inlet conveyor
- Managing all work steps through a touch screen operator panel
- Inlet conveyor independent drive means
- Glass detection IP67 ultrasonic sensor
- Inlet and outlet conveyor pneumatic clutch

Which components of the machine allow achieving high performance?

- Conveyor without bearing, consisting of pads made of special material, fixed on a double precision chain
- Mechanical system for adjusting the opening of the conveyor
- Variation of the conveyor speed by means of the inverter
- Automatic lubrication of all rotating parts
- PAR-AL: device for processing parallelograms

How can I achieve higher quality?

- Liquid cerium oxide for greater processing quality
- Lattuada spindles: a unique solution that guarantees low vibrations, robustness and limits maintenance for supreme quality
- Brushes for washing the conveyor

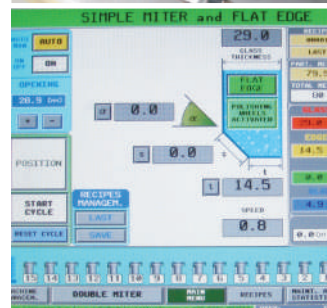
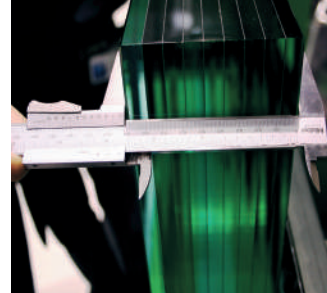

TLS SERIES

THE FLEET

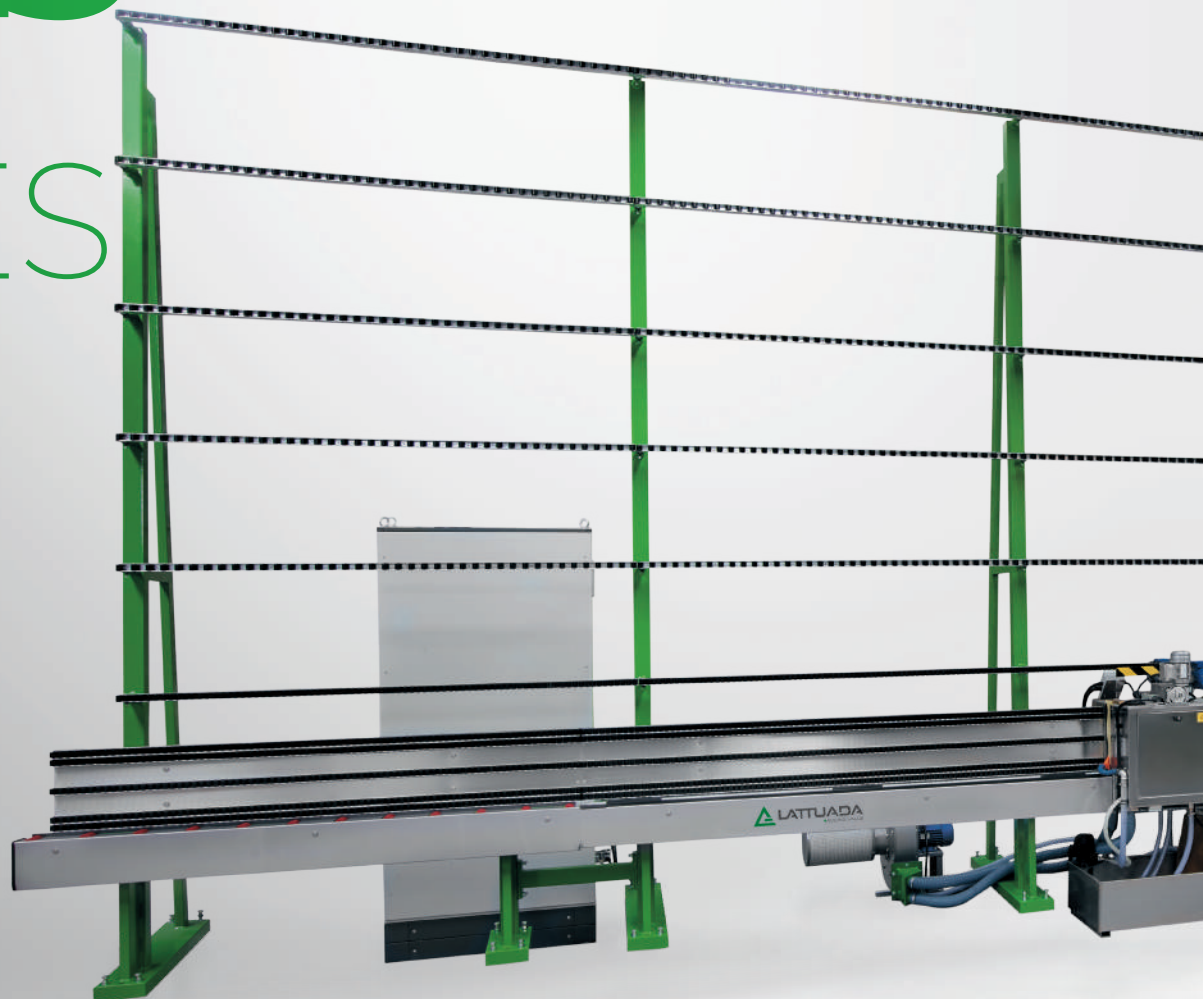



TLS AV SERIES



Electronic straight-line edging machine
with **variable angle between 0 and 45°**

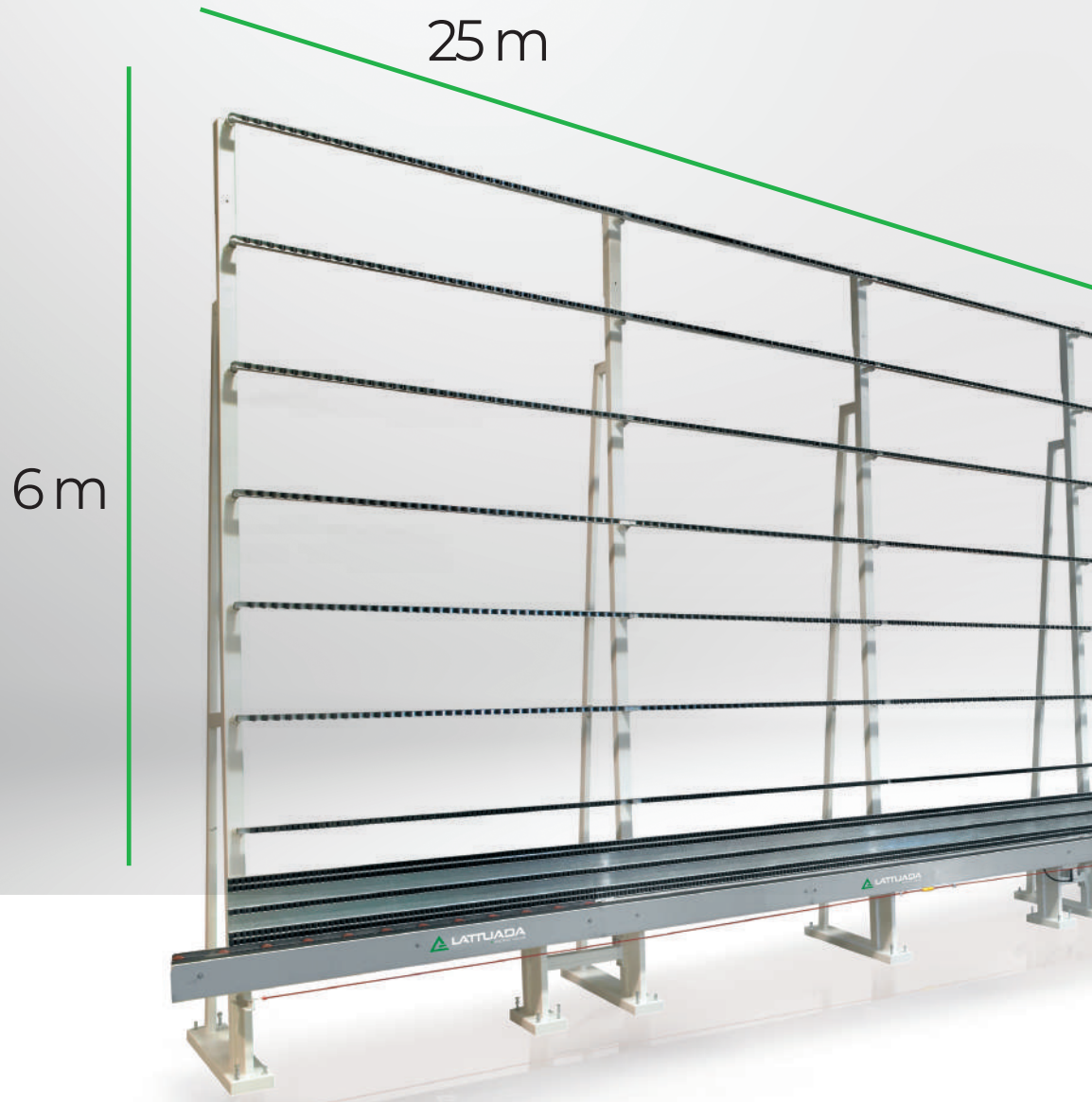

TLS AV SERIES

Electronic straight-line edging machine with **variable angle between 0 and 45°**

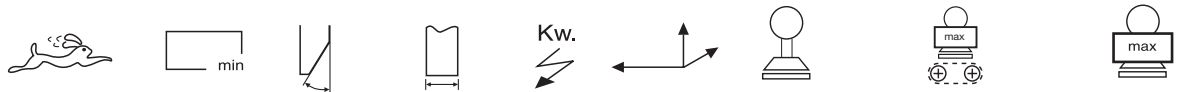

TLS 13 AV C PC	sp60/80/100	eu	0,3 - 5 m/min	H85 mm	0 - 45°	3 - 60/80/100 mm	28	10.020x1.750 xH3.700 mm	5.700 Kg	1.100 Kg - 350 Kg/m opt. 1.500 Kg - 350 Kg/m	2.200 Kg
		us	12 - 197 "/min	H3.3 "		1/8 - 2.4/3.1/3.9 "		394.5x68.9 xH145.6 "	12,566 lbs	2,425 lbs - 19.6 lbs/" opt. 3,307 lbs - 19.6 lbs/"	4,850 lbs

LEGEND

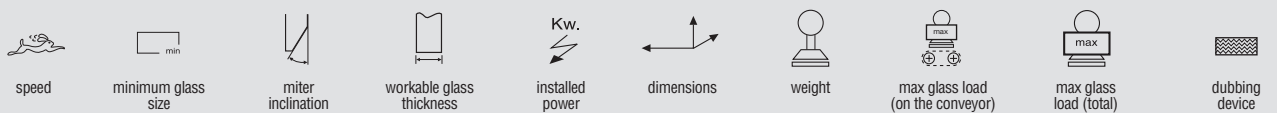



**THE BIGGEST
EDGING MACHINE
EVER BUILT!**

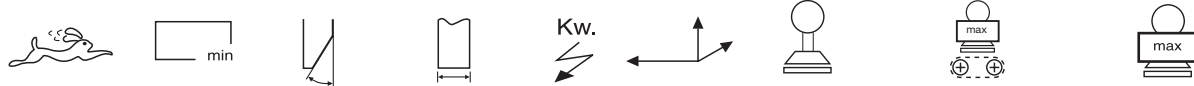

TLS 15 AV C PC	sp60/80/100	eu	0,3 - 5 m/min	H85 mm	0 - 45°	3 - 60/80/100 mm	32	10.370x1.750 xH3.700 mm	7.300 Kg	1.100 Kg - 350 Kg/m opt. 1.500 Kg - 350 Kg/m	2.200 Kg	
		us	12 - 197 "/min	H3.3 "		1/8 - 2.4/3.1/3.9 "		408.3x68.9 xH145.6 "	16,093 lbs	2,425 lbs - 19.6 lbs/" opt. 3,307 lbs - 19.6 lbs/"	4,850 lbs	

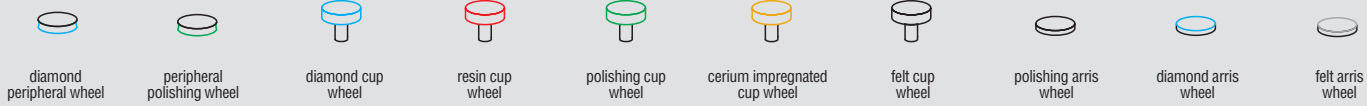



ACCESSORIES

STRAIGHT-LINE EDGING MACHINES

The washing machine applied to the edging machines and bevelling machines outlet conveyor allows the complete cleaning and drying of the processed edges of the glass sheets.



OT 300	eu	300x300 mm	the same of the machine on which it is fitted on	2 *	550x600 xH770 mm	95 Kg	2
	us	11.8x11.8 "			21.6x23.6 xH30.3 "	210 lbs	

*standard (it may change according to the included options)

PAR-AL: device for processing parallelogram-shaped glasses.



LOOK AT THE DEVICE AT WORK





PANEL

TOUCH SCREEN OPERATOR

The only one in the market capable of guaranteeing constant monitoring of the various functions of the machine through different control methods.

BASIC 4 "

Machine's data and maintenance information panel

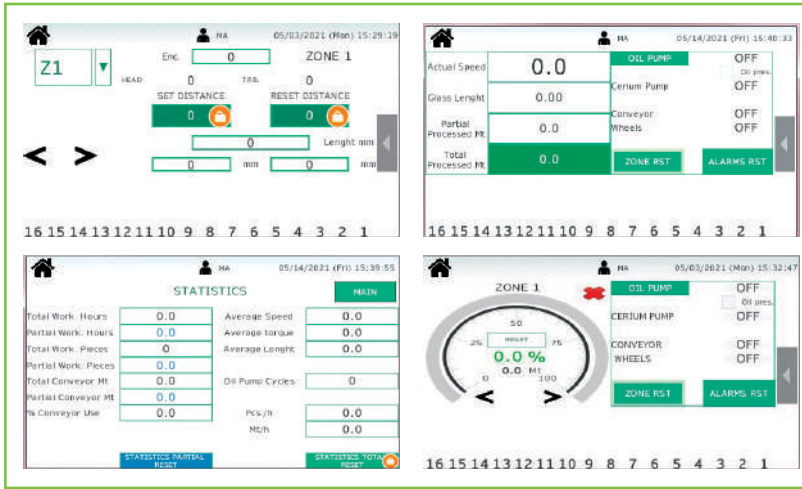

INTERMEDIATE 7.0 "

Information panel provided with additional functions with respect to the basic one

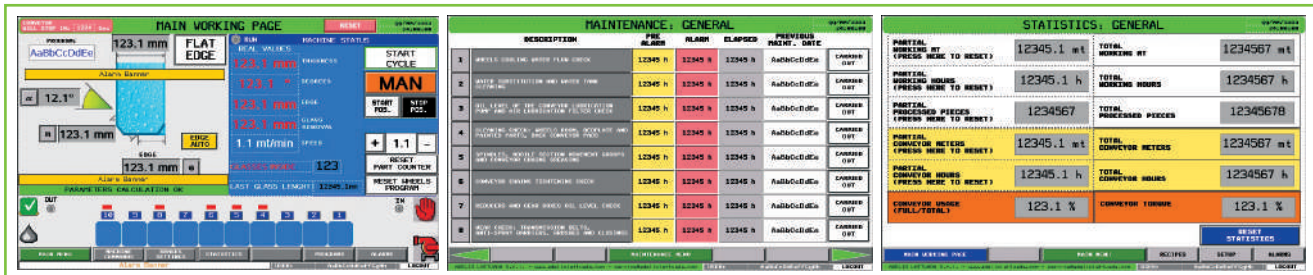

ADVANCED 10.4 "

Panel for the control and management of all work steps

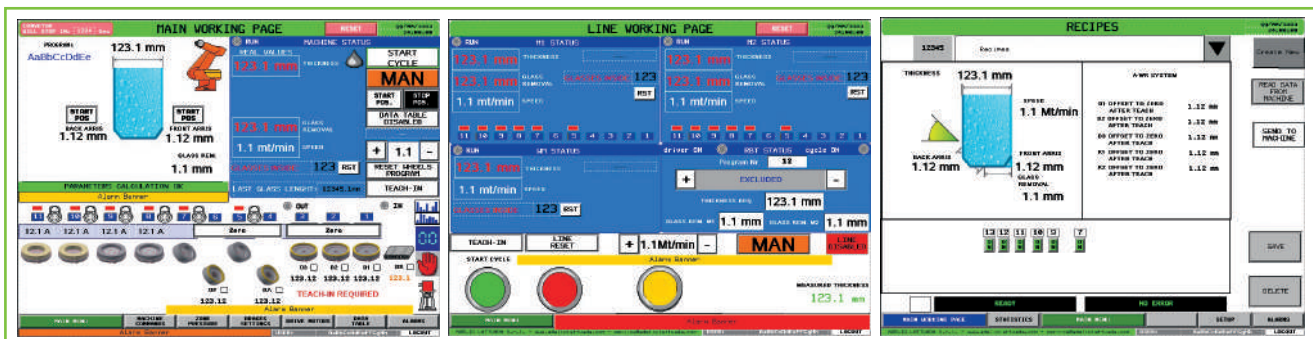

STRAIGHT-LINE BEVELLING MACHINES

TECHNICAL DETAILS

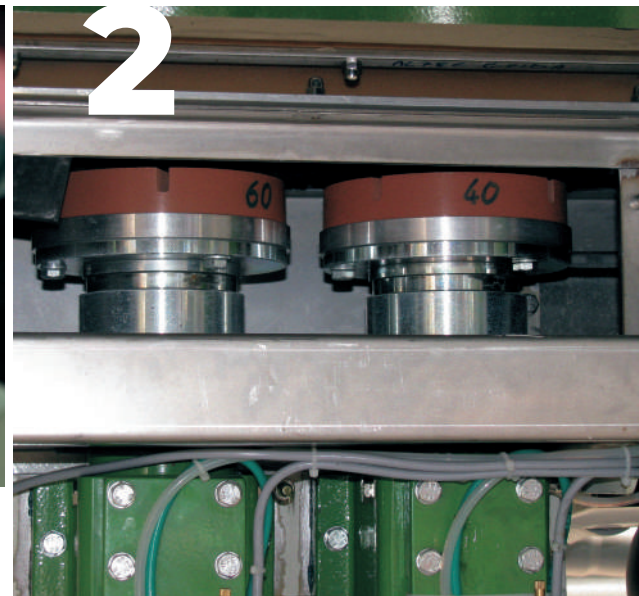

- 1 **Numerous wheel configurations** available, even customised.
- 2 **Quick and simple** wheel change.
- 3 Managing all work steps through a **touch screen operator panel**
- 4 **Ease of adjustment** when moving from one processing type to the next.
- 5 **Small piece processing** system.
- 6 OT 300 **washing machine**.
- 7 Motor absorption **digital ammeters**.
- 8 Pads washing **rotary brush**.
- 9 **Automatic** lubrication.
- 10 Variation of the conveyor speed by **means of the inverter**.
- 11 The Gamma 614 model features 4 felts: **high processing speed and quality!**

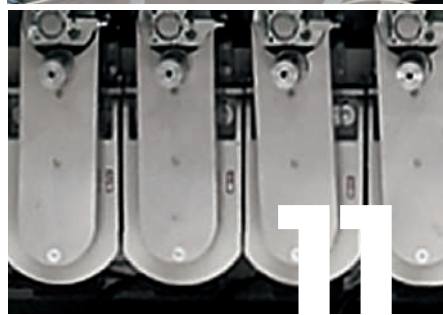
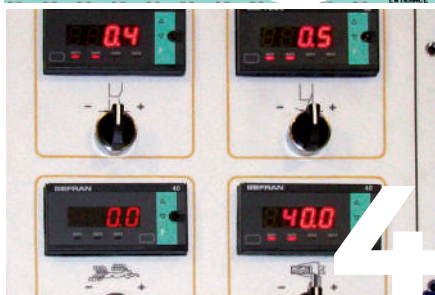
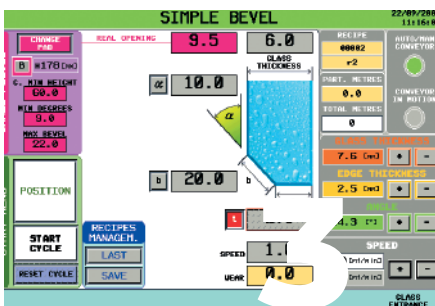

GAMMA MMA SERIES

THE WIDEST RANGE CURRENTLY AVAILABLE IN THE MARKET, IT OFFERS TECHNICAL SOLUTIONS CAPABLE OF MEETING ANY PRODUCTION NEED

GAMMA 8, which combines the versatility of a small machine with the capacity of processing on sizeable productions, even thanks to the three felts it is provided with, we go all the way to the “elder sisters”: recommended for glassmakers in need of machines capable of operating at high speeds and with utmost quality level.



3 - 20 / 25 mm
1/8 - 3/4 / 1 "



2.000 / 2.600 mm
78.7 / 102.3 "



2.450 / 3.100 mm
96.5 / 122 "



500 Kg - 150 Kg/m
1,102 lbs - 8.4 lbs/ "



mechanical

STRAIGHT-LINE BEVELLING MACHINES GAMMA SERIES **ALL YOU NEED TO KNOW**

How flexible and modular are they?

- Numerous wheel configurations available, even customised
- Possibility to integrate the OT 300 washing machine model
- Quick and simple wheel change
- Small piece processing system

Which are the processing control tools?

- Managing all work steps through a touch screen operator panel
- Variation of the conveyor speed by means of the inverter

Which components of the machine allow achieving high performance?

- Mechanical system for adjusting the opening of the conveyor
- Ease of adjustment when moving from one processing step to the next
- Pads washing rotary brush

How can I achieve higher quality?

- Liquid cerium oxide for greater processing quality
- Automatic lubrication
- Digital ammeters for a precise reading of the wheel absorption
- 4 felts: high processing speed and quality

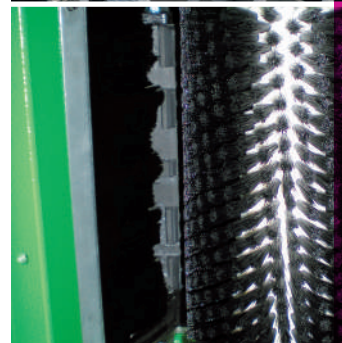

GAMMA SERIES

THE FLEET

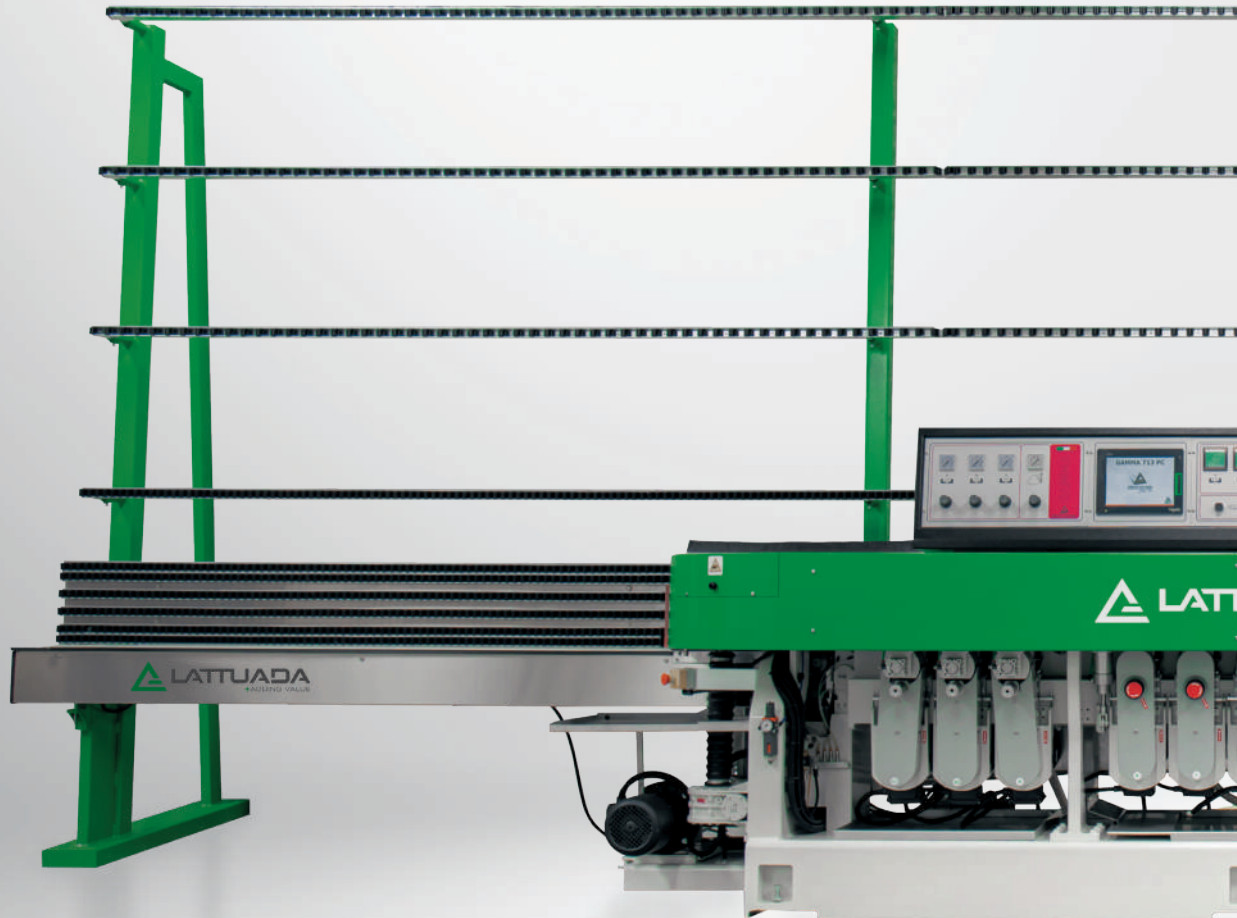

Straight-line bevelling machines
for processing **the bevel** and **flat edge with arris**,
using **liquid cerium oxide**

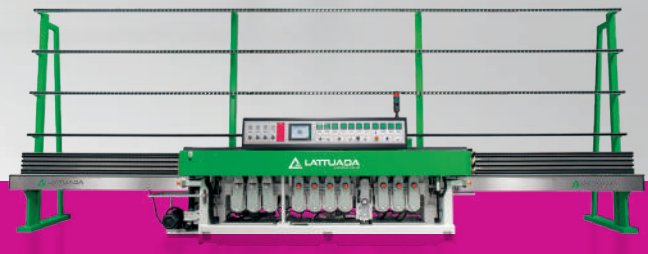
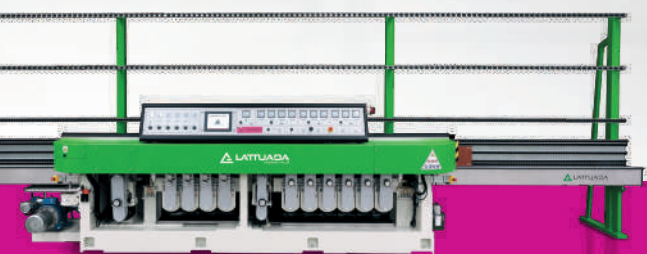
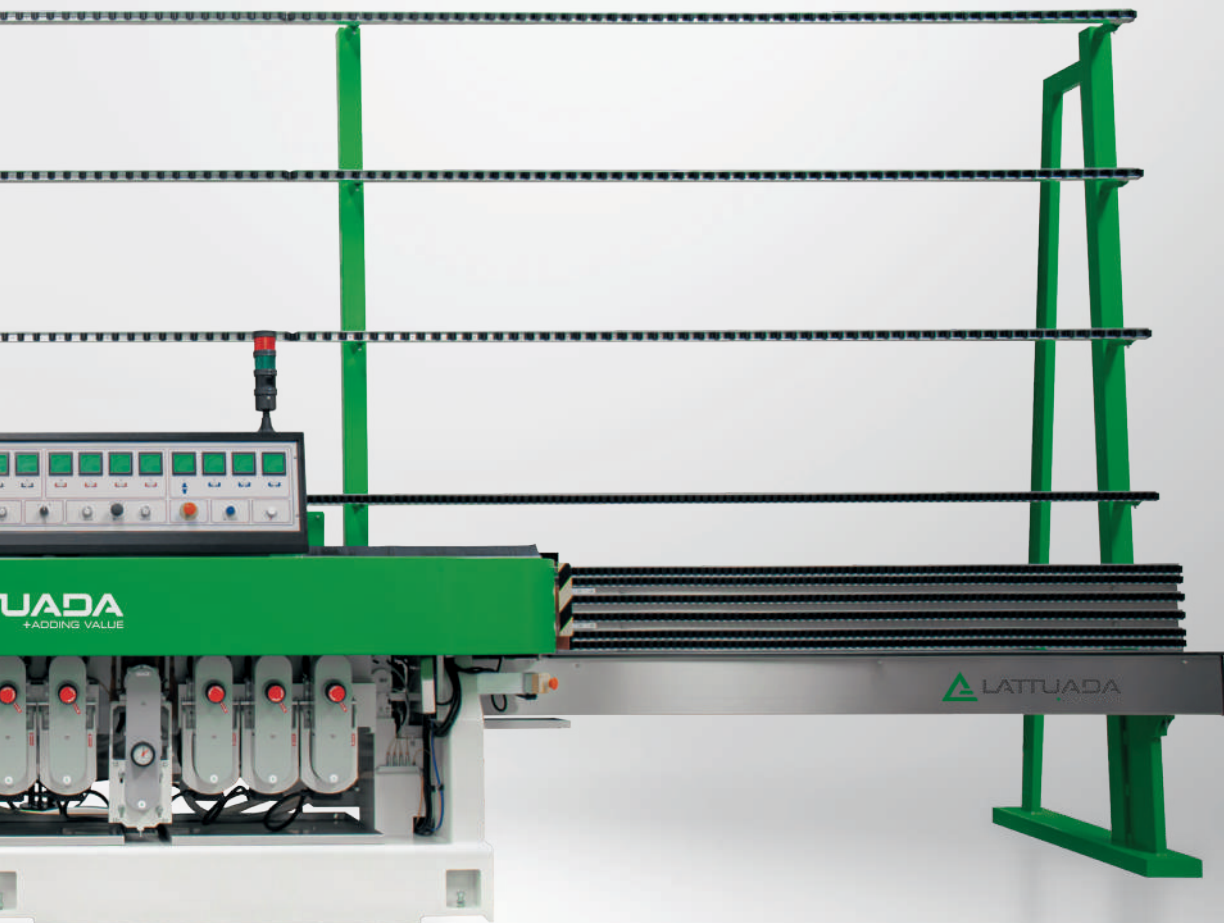

GAMMA SERIES

Straight-line bevelling machines for processing the **polished bevel using liquid cerium oxide**

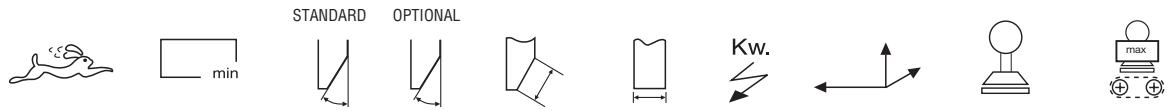

GAMMA 8	eu	0,5 - 4 m/min	110x110 mm opt. 40x40 mm	3 - 45°	3 - 25°	40 mm	3 - 20 mm	18	6.510x1.350 xH2.450 mm	2.900 Kg	500 Kg - 150 Kg/m
	us	20 - 157 "/min	4.3x4.3 " opt. 1.6x1.6 "			1.6 "	1/8 - 3/4 "		256.2x53.1 xH96.5 "	6,393 lbs	1,102 lbs - 8.4 lbs/"
	3* OPTIONAL										

GAMMA 613 PC	eu	0,3 - 5 m/min	110x110 mm opt. 40x40 mm	3 - 45°	3 - 25°	50 mm	3 - 25 mm	23	8.420x1.600 xH3.100 mm	3.900 Kg	500 Kg - 150 Kg/m
	us	12 - 197 "/min	4.3x4.3 " opt. 1.6x1.6 "			2 "	1/8 - 1 "		331.4x62.2 xH123.2 "	8,598 lbs	1,102 lbs - 8.4 lbs/"
	4* OPTIONAL										

GAMMA 614 PC	eu	0,3 - 5 m/min	110x110 mm opt. 40x40 mm	3 - 45°	3 - 25°	50 mm	3 - 25 mm	26	8.420x1.600 xH3.100 mm	4.000 Kg	500 Kg - 150 Kg/m
	us	12 - 197 "/min	4.3x4.3 " opt. 1.6x1.6 "			2 "	1/8 - 1 "		331.4x62.2 xH123.2 "	8,818 lbs	1,102 lbs - 8.4 lbs/"
	4* OPTIONAL										

GAMMA 713 PC	eu	0,3 - 5 m/min	110x110 mm opt. 40x40 mm	3 - 45°	3 - 25°	50 mm	3 - 25 mm	26	8.420x1.600 xH3.100 mm	4.000 Kg	500 Kg - 150 Kg/m
	us	12 - 197 "/min	4.3x4.3 " opt. 1.6x1.6 "			2 "	1/8 - 1 "		331.4x62.2 xH123.2 "	8,818 lbs	1,102 lbs - 8.4 lbs/"
	4* OPTIONAL										



GAMMA SERIES

Straight-line bevelling machines for processing **the bevel and pencil edge, using liquid cerium oxide**

GAMMA 633 PC	eu	0,3 - 5 m/min	110x110 mm opt. 40x40 mm	3 - 45°	3 - 25°	50 mm	3 - 25 mm	27	8.880x1.600 xH3.100 mm	4.800 Kg	500 Kg - 150 Kg/m
	us	12 - 197 "/min	4.3x4.3 " opt. 1.6x1.6 "			2 "	1/8 - 1 "		349.6x62.2 xH123.2 "	10,582 lbs	1,102 lbs - 8.4 lbs/m
	4* OPTIONAL										

GAMMA SERIES

Straight-line bevelling machines for processing **the bevel and flat edge with arris, using liquid cerium oxide**

GAMMA 643 PC	eu	0,3 - 5 m/min	110x110 mm opt. 40x40 mm	3 - 45°	50 mm	3 - 25 mm	32	8.880x1.600 xH3.100 mm	4.900 Kg	500 Kg - 150 Kg/m	
	us	12 - 197 "/min	4.3x4.3 " opt. 1.6x1.6 "		2 "	1/8 - 1 "		349.6x62.2 xH123.2 "	10,802 lbs	1,102 lbs - 8.4 lbs/m	
	4* OPTIONAL										

GAMMA 723 PC	eu	0,3 - 5 m/min	110x110 mm opt. 40x40 mm	3 - 45°	50 mm	3 - 25 mm	32	8.880x1.600 xH3.100 mm	4.900 Kg	500 Kg - 150 Kg/m	
	us	12 - 197 "/min	4.3x4.3 " opt. 1.6x1.6 "		2 "	1/8 - 1 "		349.6x62.2 xH123.2 "	10,802 lbs	1,102 lbs - 8.4 lbs/m	
	4* OPTIONAL 12* OPTIONAL										



diamond cup wheel



peripheral polishing wheel



diamond cup wheel



resin cup wheel



polishing cup wheel



felt cup wheel



polishing arris wheel



ACCESSORIES

STRAIGHT-LINE BEVELLING MACHINES



The washing machine applied to the edging machines and beveling machines outlet conveyor allows the complete cleaning and drying of the processed edges of the glass sheets.



OT 300	eu	300x300 mm	the same of the machine on which it is fitted on	2 *	550x600 xH770 mm	95 Kg	2
	us	11.8x11.8 "			21.6x23.6 xH30.3 "	210 lbs	

*standard (it may change according to the included options)



PANEL

TOUCH SCREEN OPERATOR

The only one in the market capable of guaranteeing constant monitoring of the various functions of the machine through different control methods

BASIC4 "

Machine's data and maintenance information panel



ADVANCED 10.4 "

Panel for the control and management of all work steps

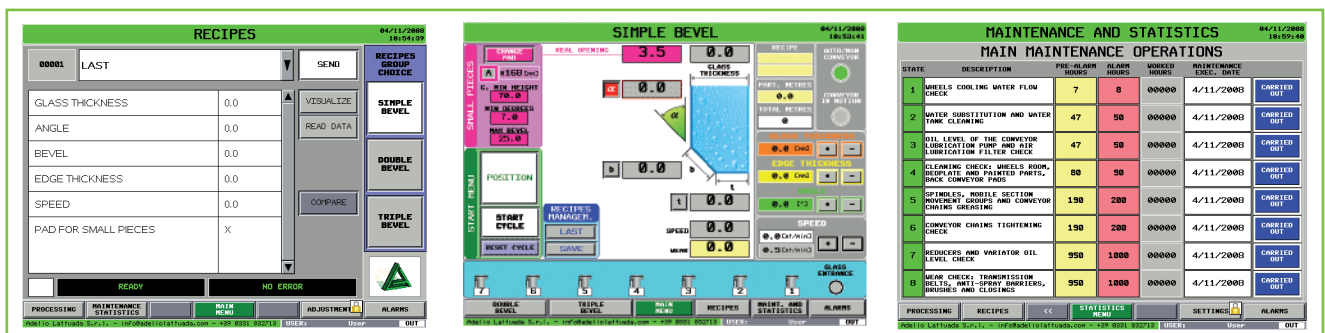

Adelio Lattuada Srl assumes no responsibility for any mistakes in the contents. All data are subject to change without notice. Images can be only representative of the products' typology.



ADELIO LATTUADA S.R.L.
Via Abbondanza, 11/13 - 22070 Carbonate (CO) IT
T. +39 0331.832713 - info@adeliolattuada.com
adeliolattuada.com

LATTUADA NORTH AMERICA, INC.
6967 Wales Road, Suite F - Northwood 43619 (OH)
T. 567 249 4486 - info@lattuada-na.com
lattuada-na.com