

WASHING

SOLUTIONS

VERTICAL WASHING MACHINES



LATTUADA
+ADDING VALUE

VERTICAL WASHING MACHINES



OT SERIES

Open top vertical washing machines

16



CT SERIES

Vertical washing machines closed on top

22



CTS SERIES

Vertical washing machines closed on top
for washing large sheets and high thicknesses

28

ADDING VALUE

THE INESTIMABLE VALUE OF GIVING AND RECEIVING

THE VALUE RECEIVED

Every person who has trusted Lattuada has enriched its story. Each glass (or stone) processing solution completed and put into production has added even more experience and drive.

THE VALUE OFFERED

Building on many years of market knowledge and a vast portfolio of successful projects, Lattuada continues to invest in development, research and training. With continually updated internal and external feedback, it strives to offer more quality, more solutions, more technology.

ADDING + VALUE

A SYNERGY OF VALUES CALLED A COMPANY

Quality and personalisation

Are the hallmark of Lattuada's design. Attention to every detail is pursued within a customised production process, with care and attention.

Flexibility and assistance

Maximum willingness to listen and develop the client's requests. Guarantee of follow-up and further customisation throughout the machine life cycle.

History and experience

Since 1978, day after day, milestone after milestone, Lattuada has continued to grow in its problem-solving capacity and in guaranteeing progressive know-how to all its customers.

Internationality and italianity

Made in Italy represents worldwide excellence in the glass sector. The sense of belonging coexists with the pride of constantly interacting with an international audience.

Innovation and substance

Proposing new solutions is part of Lattuada's DNA. Simplification, training and constant support are the pluses offered to combine technology and user-friendliness.

Eco-Sustainability and territory

Starting from the Italian headquarters, concrete actions for the environment have been undertaken for years. Likewise, Lattuada's solutions will be increasingly 'green'.

AS BIG AS THE WORLD.



HEADQUARTER



NORTHWOOD (OH)
A PRECISE CORPORATE
CHOICE TO STAY CLOSE
TO OUR CUSTOMERS

LLNA provides all pre- and after-sale services directly from the United States, including a qualified and highly professional technical support service with longstanding experience in the glass-working machine industry.

OUR SOLUTIONS ARE WORKING ALL OVER THE WORLD.
SINCE 2017 WE OPERATE IN THE USA THROUGH LATTUADA
NORTH AMERICA BASED IN NORTHWOOD (OHIO).
A PRECISE CORPORATE CHOICE TO STAY CLOSE TO OUR
CUSTOMERS BY OFFERING TOP QUALITY SERVICES AND
PRODUCTS SPECIFICALLY DESIGNED FOR A DEMANDING
AND COMPETITIVE MARKET THAT REQUIRES COMPLIANCE
TO SPECIFIC STANDARDS.



1.00+

Countries where
Lattuada machines are
installed

90+

Countries where
we are present

40+

Agents worldwide

This new company allows us to offer endless
benefits to all our US customers:

- no more problems related to transportation issues;
- machinery are invoiced directly from the United States,
eliminating the currency problem;
- specific services for the US market;
- technical support always available with
no more time zone issues;
- spare parts are supplied directly from
LATTUADA NORTH AMERICA.

integrAL

ADDING VALUES FOR INTEGRAL SOLUTIONS

INTEGRAL IS LATTUADA'S COMBINATION OF PRODUCTS, SERVICES AND TECHNOLOGY TO OFFER A SINGLE, CENTRALISED MANAGEMENT IN GLASS AND STONE PROCESSING.



SPECIAL MACHINES SOLUTIONS

Do you have any special needs?
Out-of-standard processes?
Do you treat composite materials?
That's not a problem.
We can find the most suitable solution for you and customise our machines to ensure you get the flexibility you need.



STONE SOLUTIONS

Lattuada's many years of know-how transferred to natural stone, ceramic and composite material processing: PetrA, vertical edge polisher - Works with precision and quality on all types of edges, and, thanks to its natural versatility, is perfect for Stone Professionals production facilities.

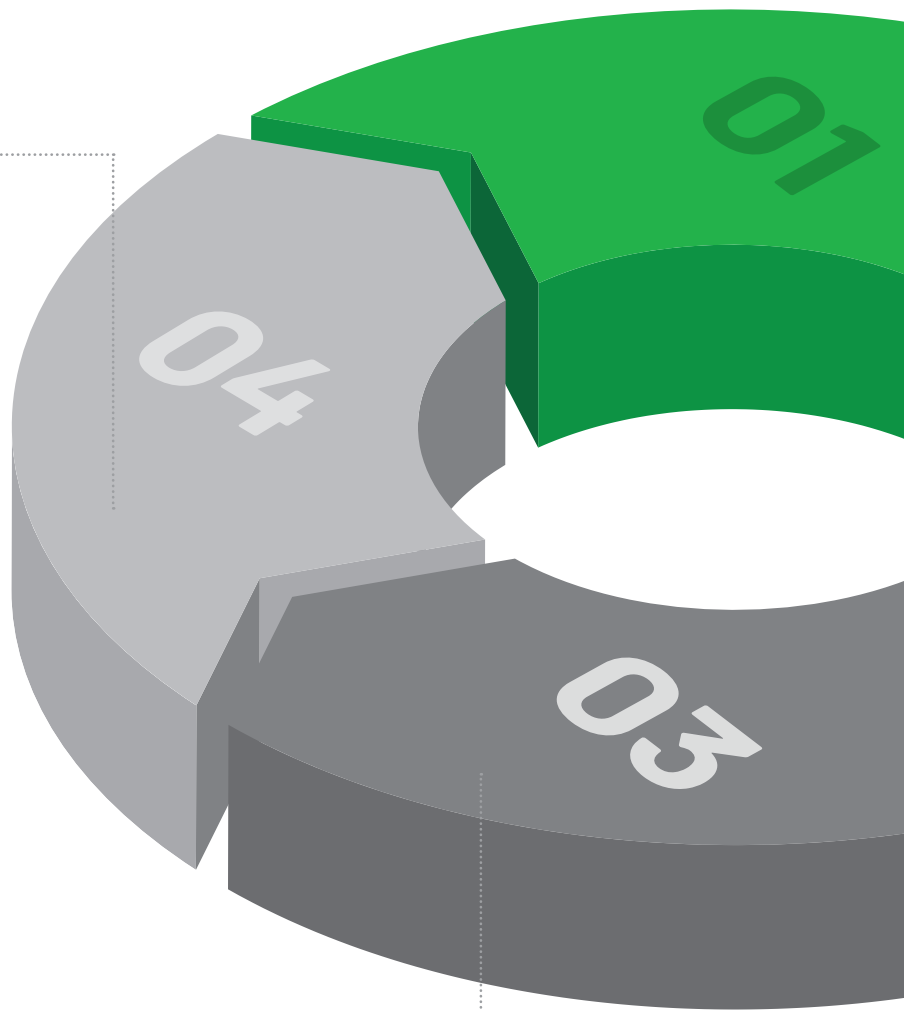



GLASS SOLUTIONS

Customisation, precision, versatility: all of Lattuada glass processing lines ensure excellent performance and high productivity, integrating perfectly into company realities. A combination of experience and innovation to meet any kind of challenge.



> Grinding

Our strength, always. A variety of solutions taking the shape of a wide range of machines: more than 40 models that can be specifically configured to ensure maximum productivity.



> Washing

For more than 15 years we have been studying and providing solutions for glass washing. We offer a full range of high-tech, vertical washing machines that are easy to use and maintain.



> Complementary processing

Do you need to drill or process corners? We can provide a complete range of horizontal drilling machines and automatic radius and straight corners grinding machines.



AUTOMATION SOLUTIONS

Robotics, A-WR & i-AL Systems, Augmented Reality and IoT: a beating heart of innovation and technology revolutionising glass and stone processing. Lattuada Automation Solutions bring companies into the world of Industry 4.0, by making every machine a concentrate of precision, productivity and automation.

“ Made in Lattuada integrated solutions, to meet all your needs ”

AUTOMATIC MACHINES
 A-WR & i-AL Systems
 ROBOTIC SOLUTIONS
 AR ASSISTANCE
 IOT

AUTOMATION SOLUTIONS

AUTOMATIC MACHINES

Solutions for automating activities and increasing production flexibility

Robots and integrations require machines with greater automation and so we added some features to the list of optionals, including:

- integration with machines upstream/downstream (in line thickness and speed adjustment)
- functions for energy saving purposes
- managing work steps through the touch-screen panel
- remote assistance and support
- data-logging and IOT
- automatic glass thickness detection
- specific modifications designed for the integration in robotic lines

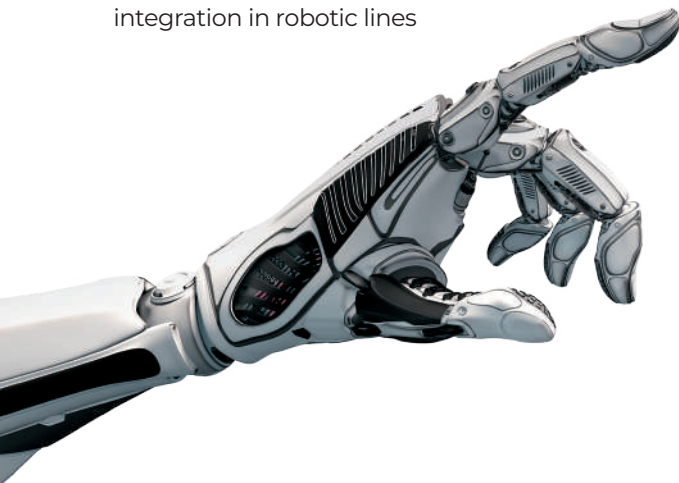

1 Touch-screen operator panel

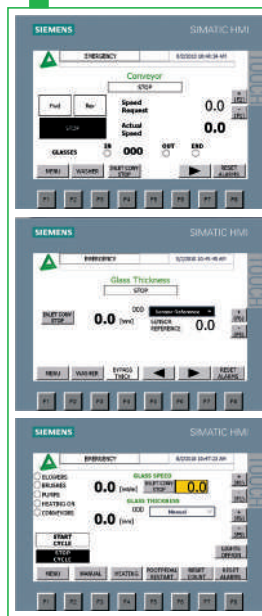

2 Sensors for automatically detecting incoming glass thickness and measuring the length of the exiting glass



3

Inlet/outlet conveyors independent drive. Independent adjustment of the speed of the front brushes



Lattuada brings companies into the world of Industry 4.0, by making every machine a concentrate of precision, productivity and automation.

EVERY CUSTOMER IS UNIQUE TO US...
AS UNIQUE AS OUR SOLUTIONS

ROBOTS

New **integrated, flexible** and **customised** solutions

* 2 edgers and 2/3 robots

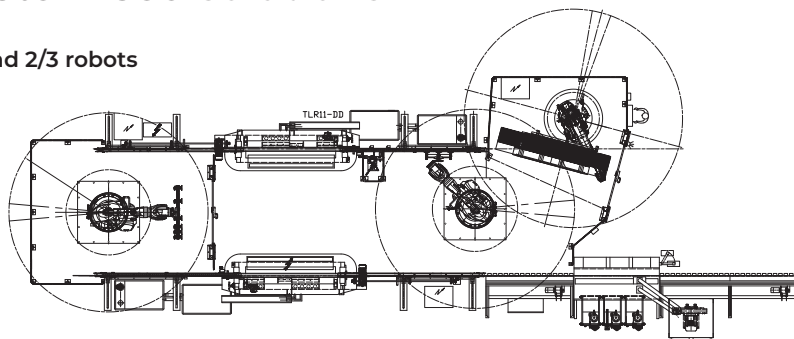

A PERFECT SYNERGY WITH TECHNOLOGY

In partnership with:



Different configurations available for the implementation in several applications:

2 EDGERS AND 1 ROBOT

The most sold

* **2 EDGERS AND 2/3 ROBOTS**

For fully automated cells

1 EDGER AND 1 ROBOT

Fully automated cell in a reduced space

4 EDGERS AND 3 ROBOTS

Special solutions

INTEGRATION

With washers, CNCs, double-edgers, cutting, tempering or IG lines, etc.

INDUSTRY 4.0

Industry 4.0 has already become an active part of many companies, becoming a strong competitive factor. An approach that deeply changes the production process by implementing enabling technologies: a leap you can already take into the future through **Adelio Lattuada** products.

SOLUTIONS FOR TRANSFORMING PRODUCTION AND BECOMING A SMART FACTORY

As a matter of fact, thanks to the **PLM IOT i-Like Machines software**, besides connecting machines to each other so as to monitor them constantly, we also provide clear data through an interface that is intuitive and easy to use.

WASHING AND DRYING GLASS SHEETS

WASHING SOLUTIONS



performing

high washing and drying capacity

Lattuada design criteria increasingly focused on each and every need as well as construction and structural robustness offer high washing and drying quality washing machines, even at high speeds and on any type of glass.



productive

smart technology

Suitable for high production loads, our washing machines can run 24/7 non-stop.



reliable

little maintenance required

All points requiring maintenance are easily accessible and the maintenance operations to be carried out are simple and quick to perform.

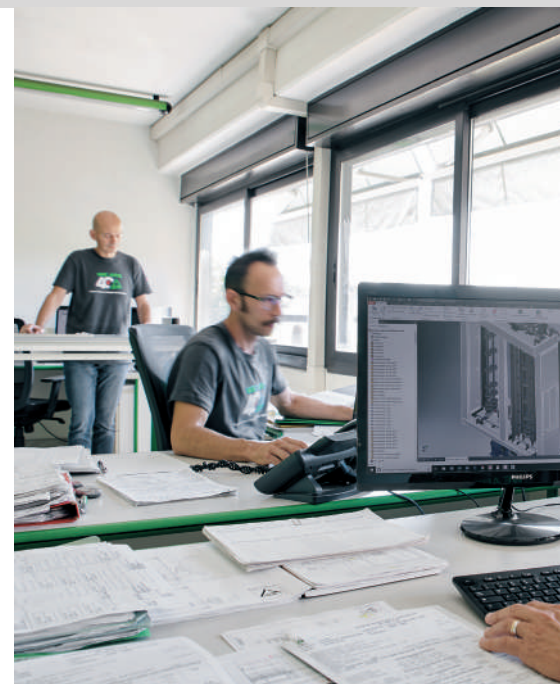

Lattuada washing machines can be integrated with different machines, such as vertical grinding, drilling and milling lines as well as CNC machines.

They differ in terms of the useful washing height, number of brushes and total loadable weights. The machine body and all parts exposed to contact with water are made of stainless steel or stainless material.



flexible

customised configurations

All Lattuada washing machine models are highly customisable and can be integrated with different machines, such as vertical grinding, drilling and milling lines as well as CNC machines.



smart

simplicity of use

Easily accessible sophisticated technology; this is our approach when it comes to building machines.



excellent

top performance

Thanks to our know-how developed and perfected in 40 years, we - at Lattuada - design and manufacture machines that offer utmost washing and drying final quality.

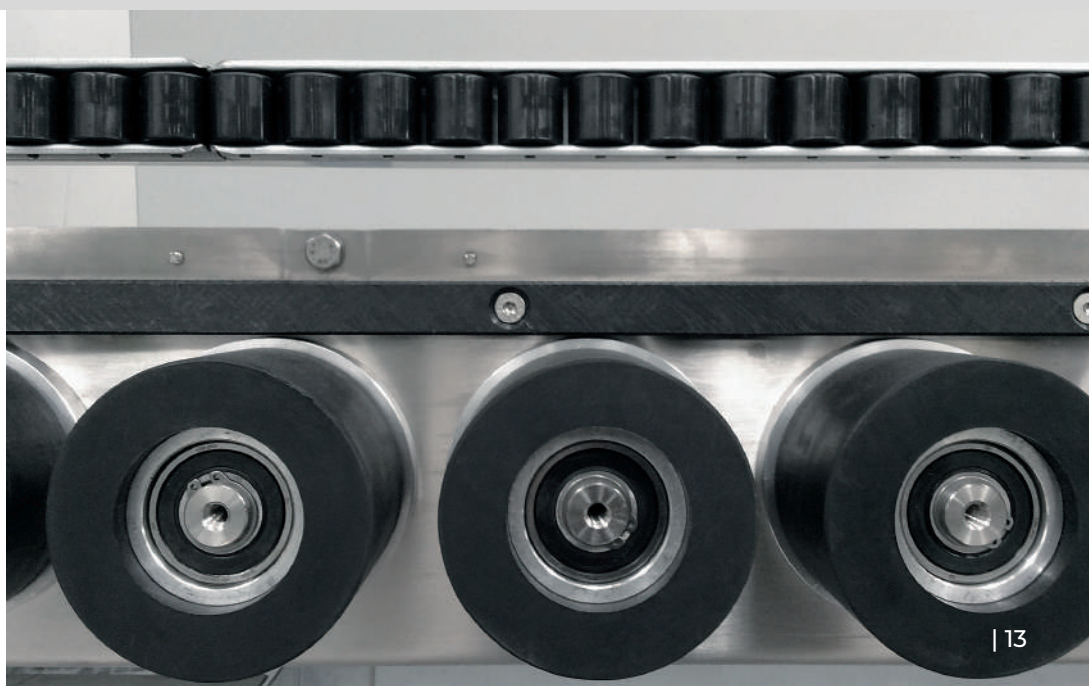
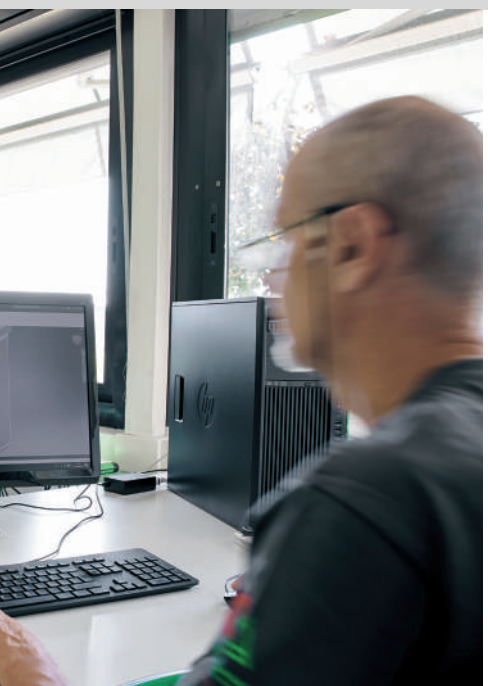

VERTICAL WASHING MACHINES

TECHNICAL DETAILS

Attention to details generates supreme quality products. Highly reliable state-of-the-art machines, in terms of precision, are our company's strong points.

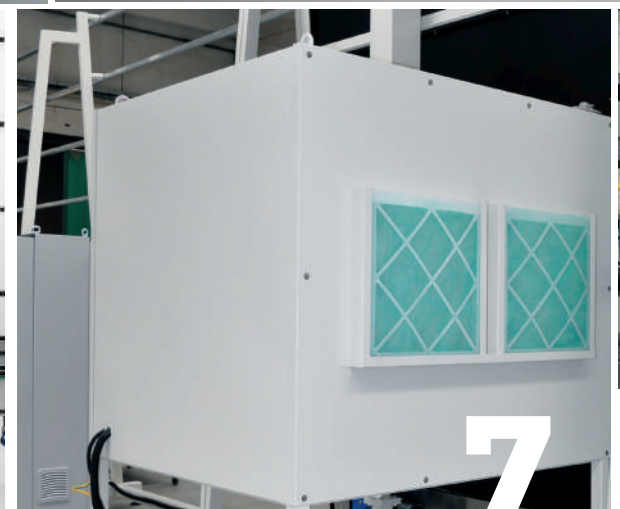
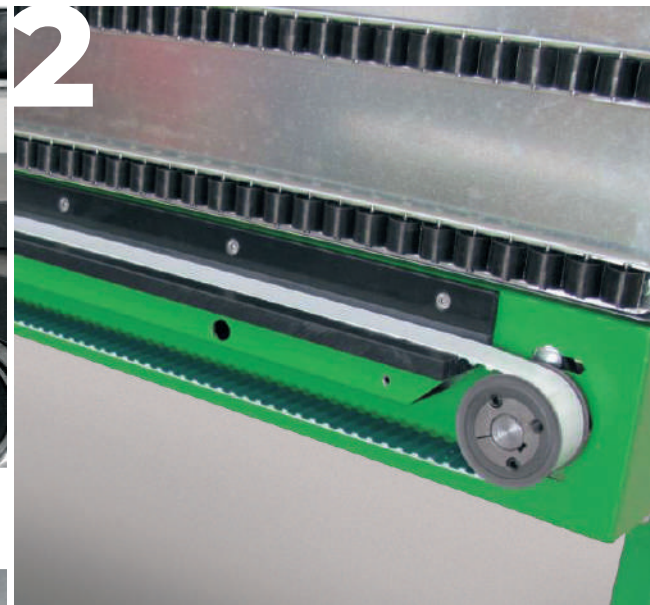
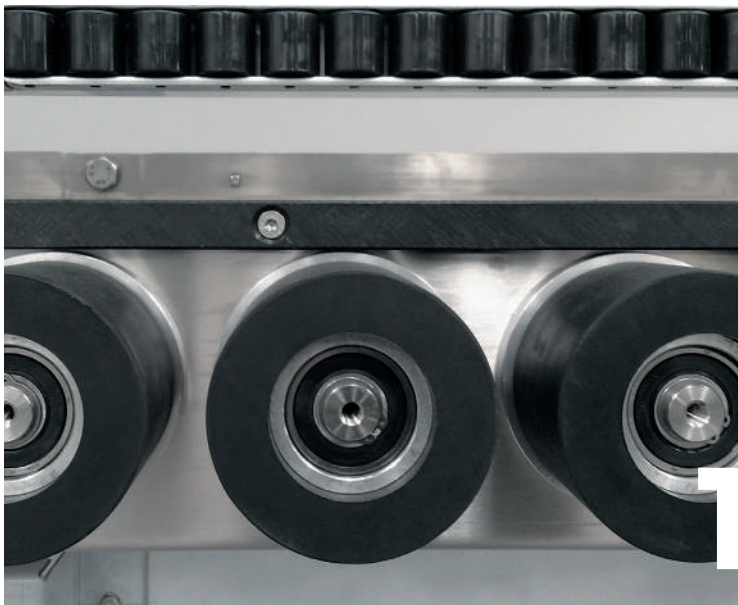

- 1 **Rollers for glass sheets** transport (special version for heavy loads).
- 2 Conveyors with belts **for washing shaped glasses**.
- 3 Brushes available for **Low-E glass** too.
- 4 Glass anti-chute **sensor and pedal**.
- 5 **Brush motors positioned at the top part** of the washing machine.
- 6 Option to position **in line** with our edging and bevelling machines.
- 7 Soundproofed **high-pressure fan**.
- 8 **Components certified** in compliance with the UL-CSA standards.
- 9 **Hot water** for pre-washing, first washing or rinsing section.
- 10 Black panel with **inspection lights**.
- 11 High soundproof **level**.



3

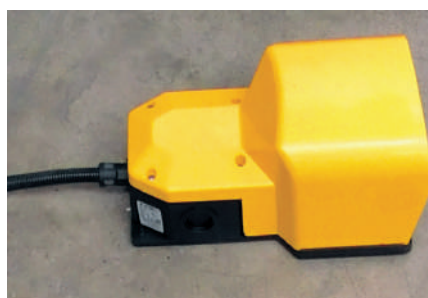

4



5



8



9



10

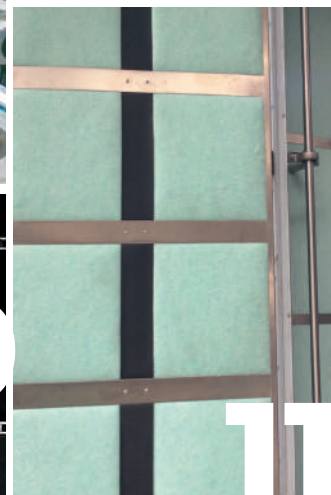

11

OT SERIES

OPEN TOP VERTICAL WASHING MACHINES

When stored, glasses are usually exposed to the risk of being scratched due to the dirt that deposits on them during processing. This problem can be solved by using an OT series washing machine, designed for washing and drying sheets, and which can be integrated with different machines, such as vertical grinding, drilling and milling lines as well as CNC machines.



3 - 15 / 20 / 25 mm
1/8 - 0.6 / 3/4 / 1 "



350xH100 mm
13.8xH3.9 "



200 / 300 / 500 kg
441 / 661 / 1,102 lbs



2 / 4 / 6

VERTICAL WASHING MACHINES OT SERIES

ALL YOU NEED TO KNOW

How flexible and modular are they?

- Conveyors with belts for washing shaped glasses are available upon request
- Option to integrate in all grinding, drilling and milling lines as well as CNC machines
- Brushes available for Low-E glass too

Which are the production control tools?

- Black panel with inspection lights
- Glass anti-chute sensor
- Thickness and speed adjustment digital displays

Which components of the machine allow achieving high performance?

- Soundproofed high-pressure fan
- Varying the conveyor speed by means of an inverter (except for series 200)
- The machine body and all parts exposed to contact with water are made of stainless steel or stainless material (no painted part)

How can I achieve higher quality?

- Hot water for pre-washing, first washing or rinsing section
- Rubber elements for displacing the glass in a cabin, made of a special rubber compound that does not damage Low-E glasses

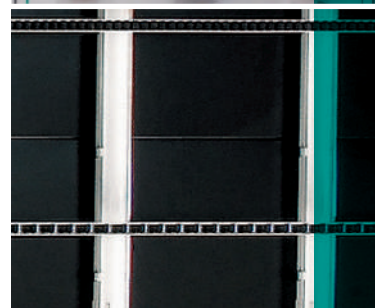
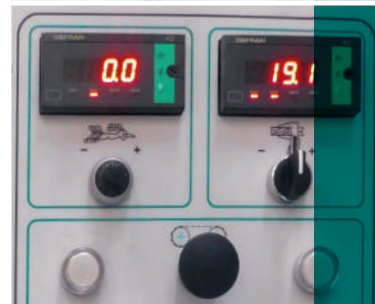
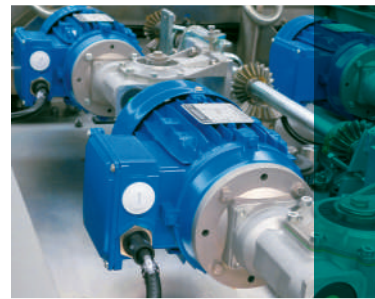
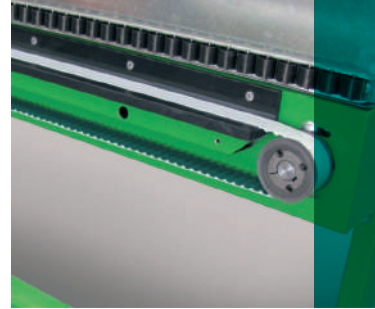

OT SE RIES

THE FLEET



OT 1600 SERIES



Open top vertical
washing machines



OT 2000 SERIES

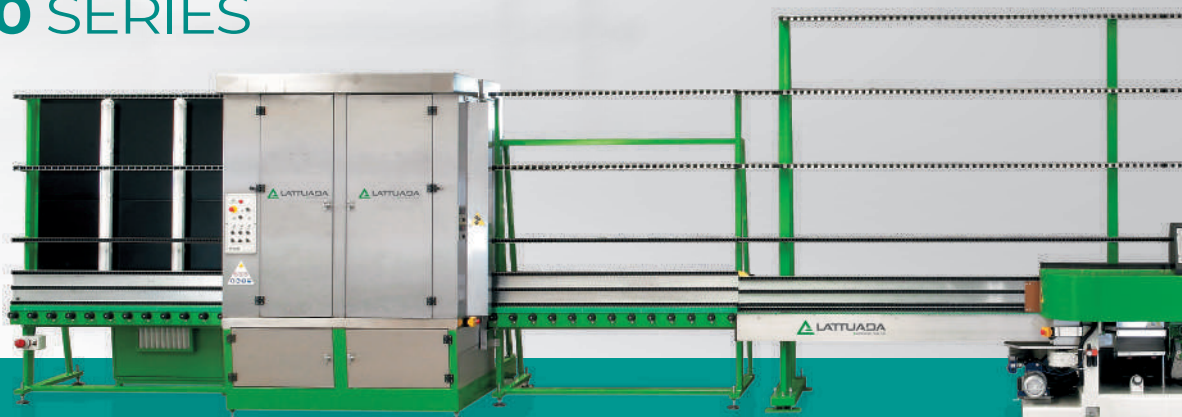

Open top vertical
washing machines

OT 1600 SERIES

Open top vertical washing machines



OT 1600 200/2s	eu	0,5 - 5 m/min	350xH100 mm*	1.600 mm	3 - 15 mm opt. 3 - 19 mm	7**	5.970x1.860 xH2.520 mm	1.200 Kg	200 Kg	2
	us	19.7 - 197 "/min	13.8xH3.9 **	63 "	1/8 - 0.6 " opt. 1/8 - 0.7 "		235x73.2 xH99.2 "	2,640 lbs	441 lbs	

OT 1600 200/4s	eu	0,5 - 5 m/min	350xH100 mm*	1.600 mm	3 - 15 mm opt. 3 - 19 mm	7**	6.220x1.860 xH2.520 mm	1.200 Kg	200 Kg	4
	us	19.7 - 197 "/min	13.8xH3.9 **	63 "	1/8 - 0.6 " opt. 1/8 - 0.7 "		244.8x73.2 xH99.2 "	2,640 lbs	441 lbs	

OT 1600 300/4s	eu	0,5 - 5 m/min	350xH100 mm*	1.600 mm	3 - 20 mm opt. 3 - 30 mm	9**	6.220x1.860 xH2.520 mm	1.600 Kg	300 Kg	4
	us	19.7 - 197 "/min	13.8xH3.9 **	63 "	1/8 - 3/4 " opt. 1/8 - 1.2 "		244.8x73.2 xH99.2 "	3,527 lbs	661 lbs	

OT 1600 300/6s	eu	0,5 - 5 m/min	350xH100 mm*	1.600 mm	3 - 20 mm opt. 3 - 30 mm	9**	6.220x1.860 xH2.520 mm	1.800 Kg	300 Kg	6
	us	19.7 - 197 "/min	13.8xH3.9 **	63 "	1/8 - 3/4 " opt. 1/8 - 1.2 "		244.8x73.2 xH99.2 "	3,968 lbs	661 lbs	

OT 1600 500/4s	eu	0,5 - 5 m/min	350xH100 mm*	1.600 mm	3 - 25 mm opt. 3 - 40 mm	9**	6.710x1.860 xH2.520 mm	2.000 Kg	500 Kg	4
	us	19.7 - 197 "/min	13.8xH3.9 **	63 "	1/8 - 1 " opt. 1/8 - 1.6 "		264.1x73.2 xH99.2 "	4,409 lbs	1,102 lbs	

OT 1600 500/6s	eu	0,5 - 5 m/min	350xH100 mm*	1.600 mm	3 - 25 mm opt. 3 - 40 mm	9**	7.210x2.060 xH2.520 mm	2.300 Kg	500 Kg	6
	us	19.7 - 197 "/min	13.8xH3.9 **	63 "	1/8 - 1 " opt. 1/8 - 1.6 "		283.8x81.1 xH99.2 "	5,070 lbs	1,102 lbs	

LEGEND



OT 2000 SERIES

Open top vertical washing machines



OT 2000/300/4s	eu	0,5 - 5 m/min	350xH100 mm*	2.000 mm	3 - 20 mm opt. 3 - 30 mm	9**	6.220x1.860 xH2.920 mm	2.000 Kg	300 Kg	4
	us	19.7 - 197 "/min	13.8xH3.9 "**	78.7 "	1/8 - 3/4 " opt. 1/8 - 1.2 "		244.8x73.2 xH114.9 "	4,409 lbs	661 lbs	

OT 2000/300/6s	eu	0,5 - 5 m/min	350xH100 mm*	2.000 mm	3 - 20 mm opt. 3 - 30 mm	9**	6.710x1.860 xH2.920 mm	2.000 Kg	300 Kg	6
	us	19.7 - 197 "/min	13.8xH3.9 "**	78.7 "	1/8 - 3/4 " opt. 1/8 - 1.2 "		264.1x73.2 xH114.9 "	4,409 lbs	661 lbs	

OT 2000/500/4s	eu	0,5 - 5 m/min	350xH100 mm*	2.000 mm	3 - 25 mm opt. 3 - 40 mm	14**	6.710x1.860 xH2.920 mm	2.400 Kg	500 Kg	4
	us	19.7 - 197 "/min	13.8xH3.9 "**	78.7 "	1/8 - 1 " opt. 1/8 - 1.6 "		264.1x73.2 xH114.9 "	5,291 lbs	1,102 lbs	

OT 2000/500/6s	eu	0,5 - 5 m/min	350xH100 mm*	2.000 mm	3 - 25 mm opt. 3 - 40 mm	14**	7.210x2.060 xH2.920 mm	2.700 Kg	500 Kg	6
	us	19.7 - 197 "/min	13.8xH3.9 "**	78.7 "	1/8 - 1 " opt. 1/8 - 1.6 "		283.8x81.1 xH114.9 "	5,952 lbs	1,102 lbs	

* others on request
** standard (may vary depending on options potentially included)

CT SERIES

VERTICAL WASHING MACHINES CLOSED ON TOP

When stored, glasses are usually exposed to the risk of being scratched due to the dirt that deposits on them during processing. This problem can be solved by using a CT series washing machine, designed for washing and drying sheets, and which can be integrated with different machines, such as vertical grinding, drilling and milling lines as well as CNC machines.



3 - 25 mm
1/8 - 1 "



400xH100 mm
15.7xH3.9 "



500 kg
1,102 lbs



4 / 6

VERTICAL WASHING MACHINES CT SERIES

ALL YOU NEED TO KNOW

How flexible and modular are they?

- Option to be integrated in all grinding, drilling and milling lines as well as CNC machines
- Brushes available for Low-E glass too
- High efficiency soundproofing
- Functions facilitating energy saving included

Which are the production control tools?

- Touch screen operator panel
- Black panel with inspection lights
- Glass anti-chute sensor
- Inlet/outlet conveyors independent drive means
- Independent adjustment of the speed of the front brushes

Which components of the machine allow achieving high performance?

- Soundproofed high-pressure fan
- Varying the conveyor speed by means of an inverter
- Ultrasonic sensor for automatically detecting the incoming glass thickness

How can I achieve higher quality?

- Hot water for pre-washing, first washing or rinsing section (UL/CSA version too)
- The machine body and all parts exposed to contact with water are made of stainless steel or stainless material (no painted part) - AISI 316 stainless steel also available upon request
- Separate pre-washing section
- Pumps suitable for distilled water

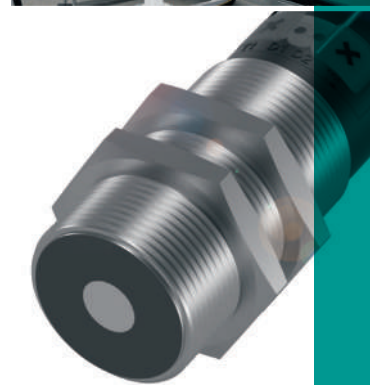
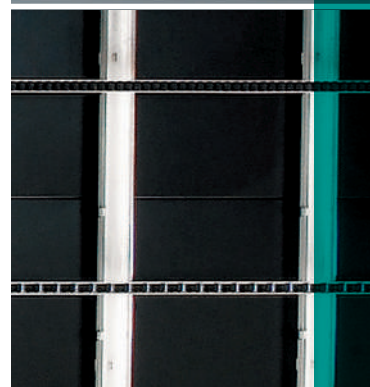
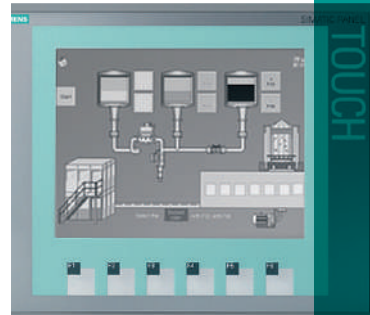
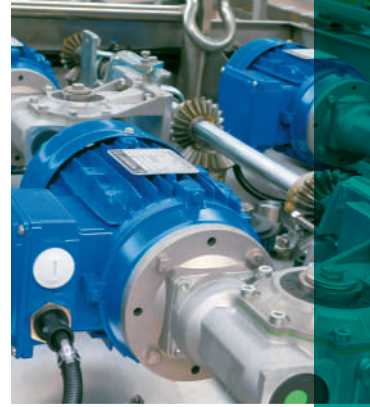

CT SERIES

THE FLEET



CT 2600 SERIES

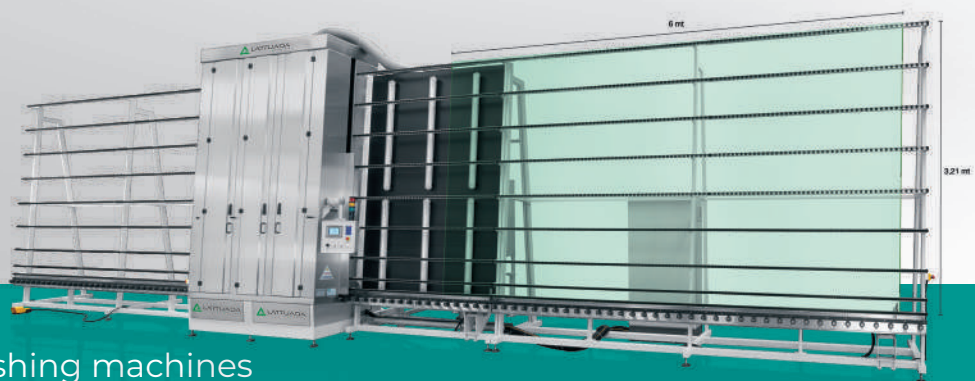

Vertical washing machines
closed on top



CT 3300 SERIES



Vertical washing machines
closed on top

CT 2600 SERIES

Vertical washing machines closed on top

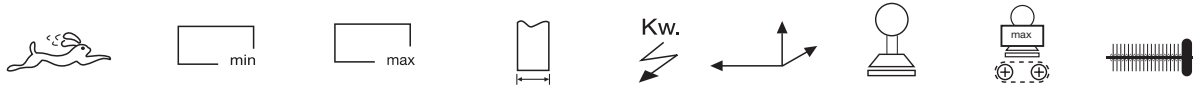

CT 2600/500/4s	eu	0,5 - 5 m/min	400xH100 mm*	2.600 mm	3 - 25 mm opt. 3 - 40 mm	19**	7.950x2.450 xH3.590 mm	3.500 Kg	500 Kg opt. 800 Kg	4
	us	19.7 - 197 "/min	15.7xH3.9 "**	102.3 "	1/8 - 1 " opt. 1/8 - 1.6 "		312.9x96.4 xH141.3 "	7,716 lbs	1,102 lbs opt. 1,764 lbs	

CT 2600/500/6s	eu	0,5 - 5 m/min	400xH100 mm*	2.600 mm	3 - 25 mm opt. 3 - 40 mm	23**	8.630x2.450 xH3.590 mm	4.000 Kg	500 Kg opt. 800 Kg	6
	us	19.7 - 197 "/min	15.7xH3.9 "**	102.3 "	1/8 - 1 " opt. 1/8 - 1.6 "		341.3x96.4 xH141.3 "	8,818 lbs	1,102 lbs opt. 1,764 lbs	



speed



minimum
glass size



maximum
glass size



workable glass
thickness



Kw.
installed
power



dimensions



weight



max glass load
(on the conveyor)



brushes

CT 3300 SERIES

Vertical washing machines closed on top



CT 3300/500/4s	eu	0,5 - 5 m/min	400xH100 mm*	3.300 mm	3 - 25 mm opt. 3 - 40 mm	23**	9.440x2.450 xH4.290 mm	4.000 Kg	500 Kg opt. 800 Kg	4
	us	19.7 - 197 "/min	15.7xH3.9 "**	129.9 "	1/8 - 1 " opt. 1/8 - 1.6 "		371.6x96.4 xH168.8 "	8,818 lbs	1,102 lbs opt. 1,764 lbs	

CT 3300/500/6s	eu	0,5 - 5 m/min	400xH100 mm*	3.300 mm	3 - 25 mm opt. 3 - 40 mm	23**	10.140x2.450 xH4.290 mm	4.500 Kg	500 Kg opt. 800 Kg	6
	us	19.7 - 197 "/min	15.7xH3.9 "**	129.9 "	1/8 - 1 " opt. 1/8 - 1.6 "		399.2x96.4 xH168.8 "	9,920 lbs	1,102 lbs opt. 1,764 lbs	

* others on request
** standard (may vary depending on options potentially included)

CTS SERIES

VERTICAL WASHING MACHINES CLOSED ON TOP

The Lattuada CTS series models are washing machines designed for glassmakers handling **major volumes of large sheets and high thicknesses.**



3 - 60/80 mm
1/8 - 2.3/3.1 "



400xH100 mm
15.7xH3.9 "



800/1.500 kg
1,764/3,306 lbs



4/6

VERTICAL WASHING MACHINES CTS SERIES

ALL YOU NEED TO KNOW

How flexible and modular are they?

- Rollers for glass sheets transport (special version for heavy loads)
- Option to be integrated in all grinding, drilling and milling lines as well as CNC machines
- Brushes available for Low-E glass too
- High efficiency soundproofing
- Functions facilitating energy saving included

Which are the production control tools?

- Touch screen operator panel
- Black panel with inspection lights
- Glass anti-chute sensor
- Inlet/outlet conveyors independent drive means
- Independent adjustment of the speed of the front brushes

Which components of the machine allow achieving high performance?

- Soundproofed high-pressure fan
- Varying the conveyor speed by means of an inverter
- Ultrasonic sensor for automatically detecting the incoming glass thickness

How can I achieve higher quality?

- Hot water for pre-washing, rinsing à first washing or rinsing section (UL/CSA version too)
- The machine body and all parts exposed to contact with water are made of stainless steel or stainless material (no painted part) - AISI 316 stainless steel also available upon request
- Separate pre-washing section
- Pumps suitable for distilled water

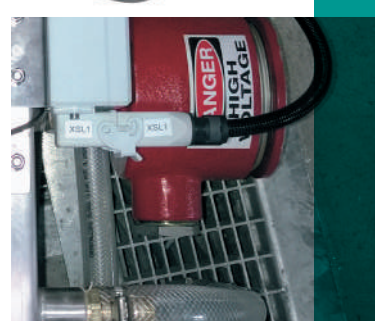
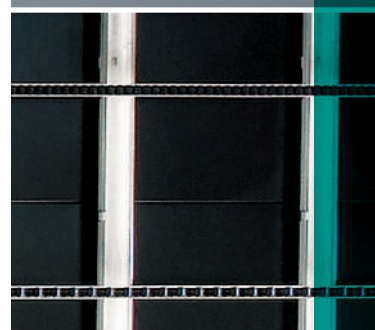
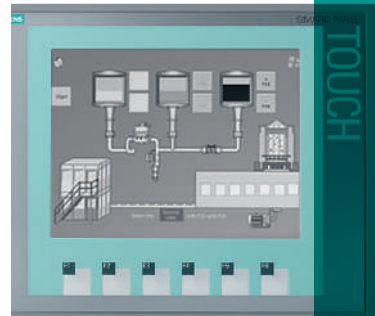
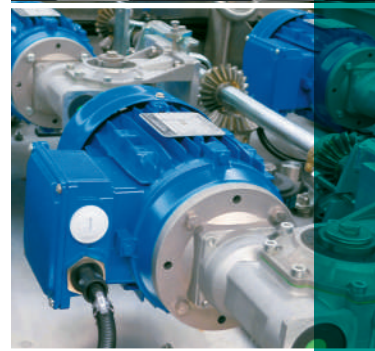

CTS SERIES

THE FLEET



CTS 2600 SERIES

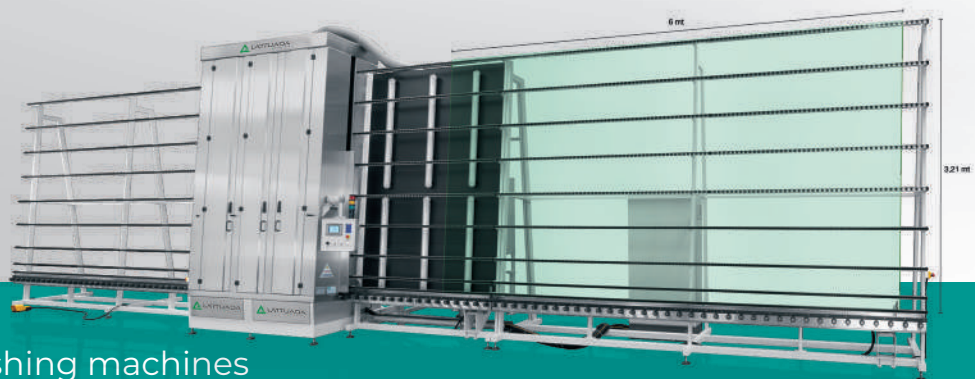

Vertical washing machines
closed on top



CTS 3300 SERIES



Vertical washing machines
closed on top

CTS 2600 SERIES

Vertical washing machines closed on top



CTS 2600 800/4s	eu	0,5 - 5 m/min	400xH100 mm*	2.600 mm	3 - 60 mm	23**	7.950x2.450 xH3.590 mm	4.000 Kg	800 Kg opt. 1.000 Kg	4
	us	19.7 - 197 "/min	15.7xH3.9 "**	102.3 "	1/8 - 2.3 "		312.9x96.4 xH141.3 "	8,818 lbs	1,764 lbs opt. 2,204 lbs	
CTS 2600 800/6s	eu	0,5 - 5 m/min	400xH100 mm*	2.600 mm	3 - 60 mm	23**	8.670x2.450 xH3.590 mm	4.000 Kg	800 Kg opt. 1.000 Kg	6
	us	19.7 - 197 "/min	15.7xH3.9 "**	102.3 "	1/8 - 2.3 "		341.3x96.4 xH141.3 "	8,818 lbs	1,764 lbs opt. 2,204 lbs	
CTS 2600 1500/4s	eu	0,5 - 5 m/min	400xH100 mm*	2.600 mm	3 - 80 mm	23**	8.780x2.465 xH3.590 mm	4.000 Kg	1.500 Kg opt. 2.000 Kg	4
	us	19.7 - 197 "/min	15.7xH3.9 "**	102.3 "	1/8 - 3.1 "		345.6x97 xH141.3 "	8,818 lbs	3,306 lbs opt. 4,409 lbs	
CTS 2600 1500/6s	eu	0,5 - 5 m/min	400xH100 mm*	2.600 mm	3 - 80 mm	23**	9.120x2.465 xH3.590 mm	4.000 Kg	1.500 Kg opt. 2.000 Kg	6
	us	19.7 - 197 "/min	15.7xH3.9 "**	102.3 "	1/8 - 3.1 "		359x97 xH141.3 "	8,818 lbs	3,306 lbs opt. 4,409 lbs	

CTS 3300 SERIES

Vertical washing machines closed on top



CTS 3300 800/4s	eu	0,5 - 5 m/min	400xH100 mm*	3.300 mm	3 - 60 mm	23**	9.440x2.450 xH4.290 mm	4.500 Kg	800 Kg opt. 1.000 Kg	4
	us	19.7 - 197 "/min	15.7xH3.9 "**	129.9 "	1/8 - 2.3 "		371.6x96.4 xH168.8 "	9,920 lbs	1,764 lbs opt. 2,204 lbs	
CTS 3300 800/6s	eu	0,5 - 5 m/min	400xH100 mm*	3.300 mm	3 - 60 mm	23**	10.160x2.450 xH4.290 mm	4.500 Kg	800 Kg opt. 1.000 Kg	6
	us	19.7 - 197 "/min	15.7xH3.9 "**	129.9 "	1/8 - 2.3 "		400x96.4 xH168.8 "	9,920 lbs	1,764 lbs opt. 2,204 lbs	



CTS 3300 SERIES

Vertical washing machines closed on top



CTS 3300 1500/4s	eu	0,5 - 5 m/min	400xH100 mm*	3.300 mm	3 - 80 mm	23**	10.270x2.465 xH4.290 mm	4.500 Kg	1.500 Kg opt. 2.000 Kg	4
	us	19.7 - 197 "/min	15.7xH3.9 "**	129.9 "	1/8 - 3.1 "		404.3x97 xH168.8 "	9,920 lbs	3,306 lbs opt. 4,409 lbs	
CTS 3300 1500/6s	eu	0,5 - 5 m/min	400xH100 mm*	3.300 mm	3 - 80 mm	23**	10.610x2.465 xH4.290 mm	4.500 Kg	1.500 Kg opt. 2.000 Kg	6
	us	19.7 - 197 "/min	15.7xH3.9 "**	129.9 "	1/8 - 3.1 "		417.7x97 xH168.8 "	9,920 lbs	3,306 lbs opt. 4,409 lbs	

ACCESSORIES

VERTICAL WASHING MACHINES

The washing machine applied to the **edging machines and bevelling machines** outlet conveyor allows the complete cleaning and drying of the processed edges of the glass sheets.



OT 300	eu	300x300 mm*	the same of the machine on which it is fitted on	2 **	550x600 xH770 mm	95 Kg	2
	us	11.8x11.8 "**			21.6x23.6 xH30.3 "	210 lbs	

* others on request
** standard (may vary depending on options potentially included)

* others on request
** standard (may vary depending on options potentially included)



PANEL

TOUCH SCREEN OPERATOR

The only ones in the market capable of guaranteeing constant monitoring of the various functions of the machine through different control methods.

Panel for the control and management of all work steps

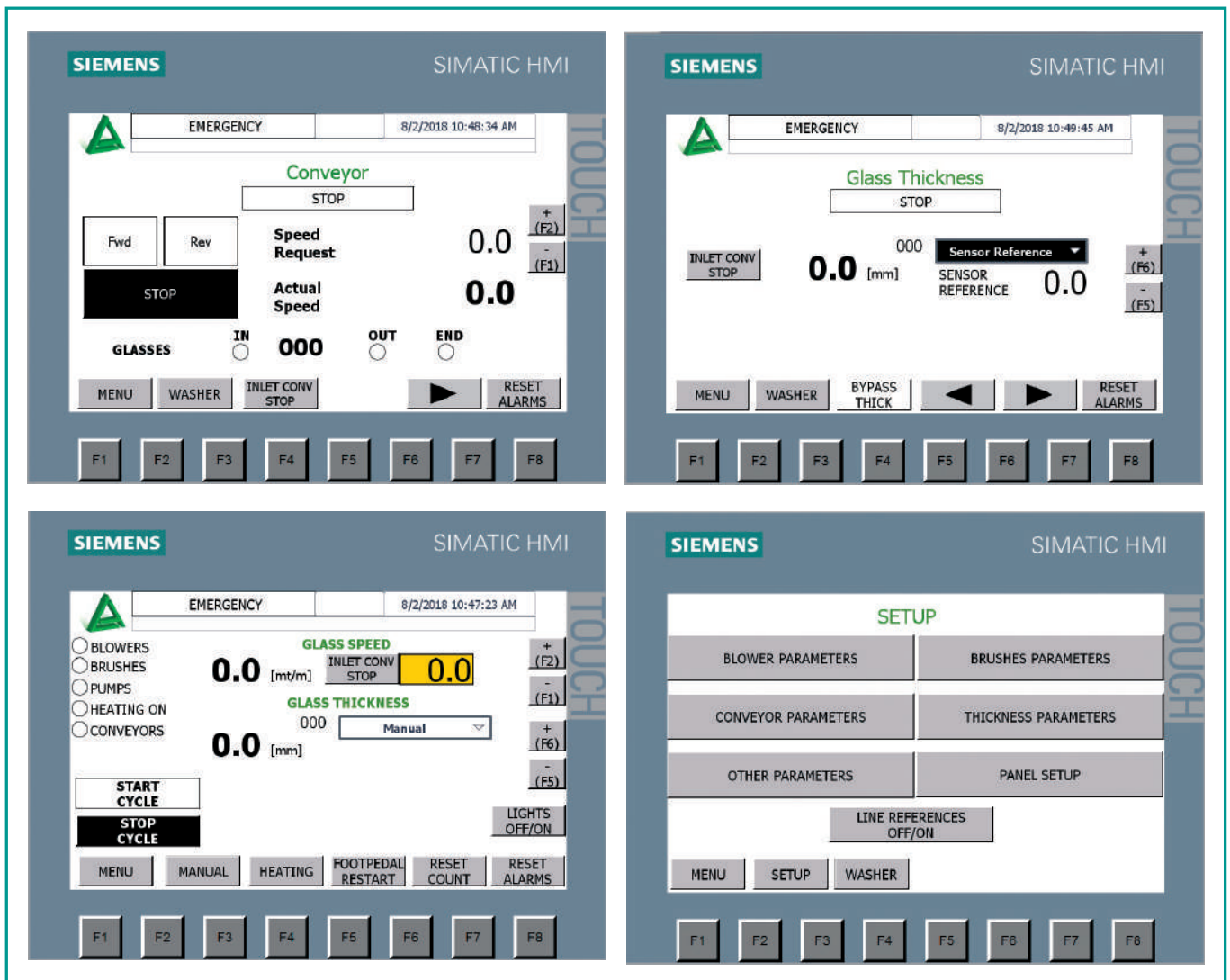

Adelio Lattuada Srl assumes no responsibility for any mistakes in the contents.
All data are subject to change without notice.
Images can be only representative of the products' typology.



ADELIO LATTUADA S.R.L.
Via Abbondanza, 11/13 - 22070 Carbonate (CO) IT
T. +39 0331.832713 - info@adeliolattuada.com
adeliolattuada.com

LATTUADA NORTH AMERICA, INC.
6967 Wales Road, Suite F - Northwood 43619 (OH)
T. 567 249 4486 - info@lattuada-na.com
lattuada-na.com